





Assembly code	Assembly revision	Assembly image
ASM1520A/0.D03	Cooking chamber	
ASM1521A/0.D01	External cover	
ASM0315A/0.D01	Door	



**ASM1520A/0.D03 - Cooking chamber**

**FRONT**

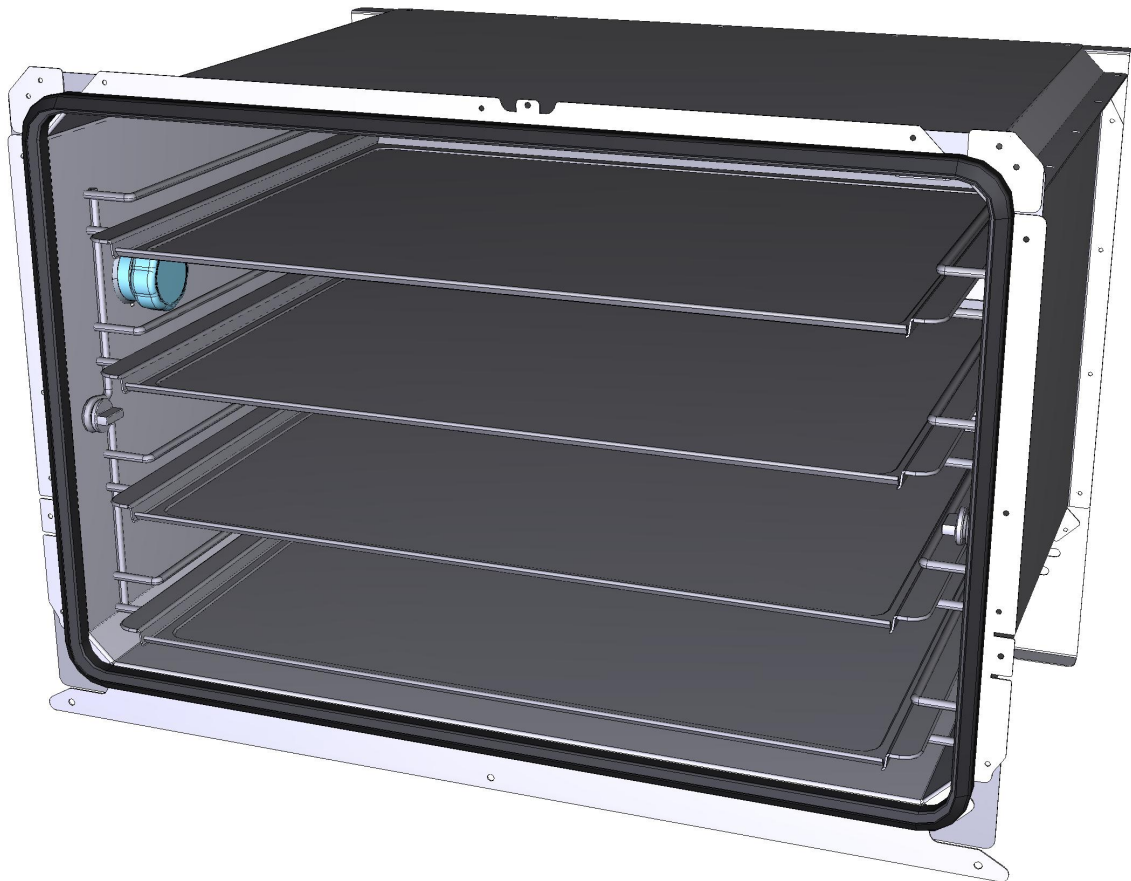

ASM1520A/0.D03 - Cooking chamber

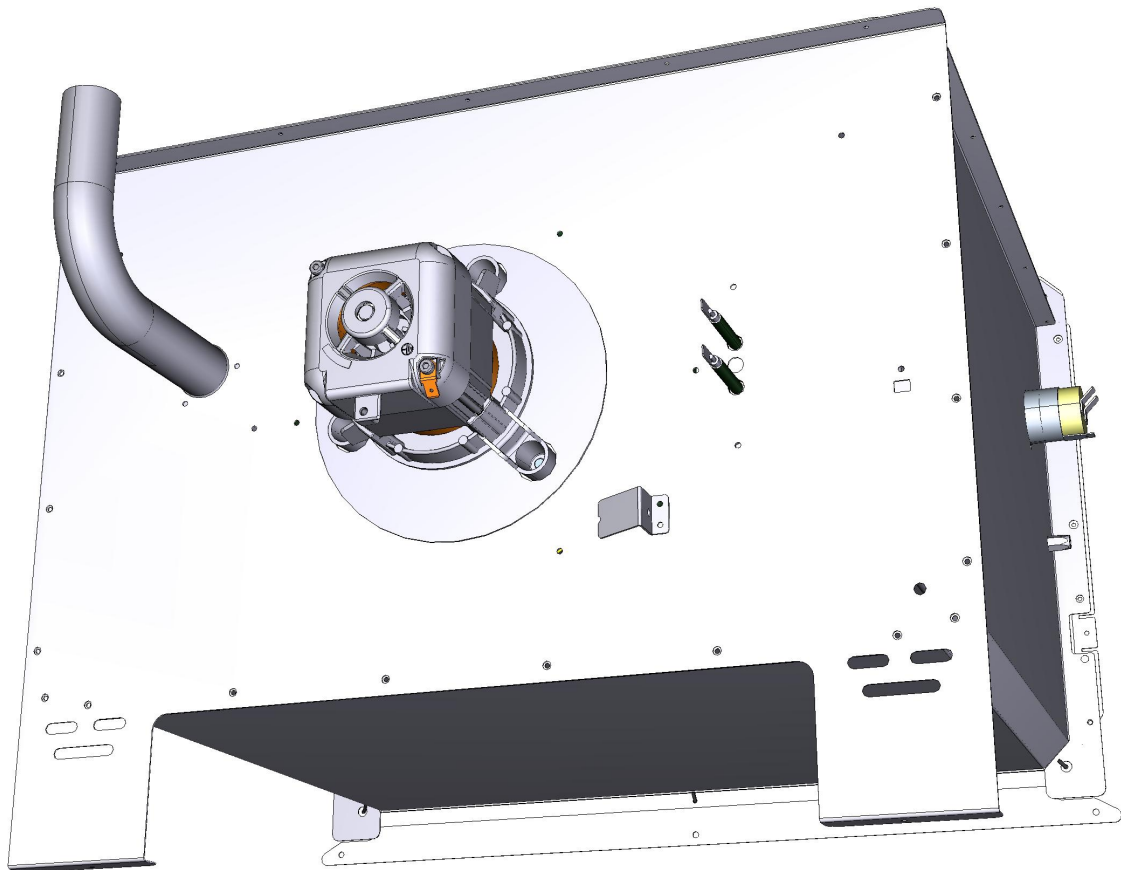

REAR







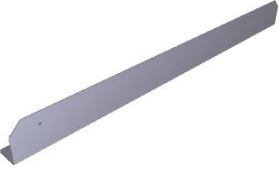
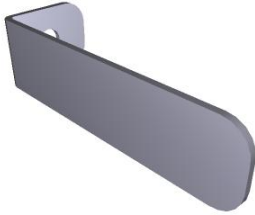
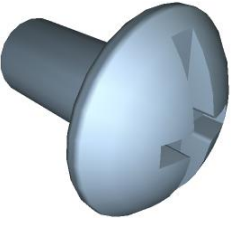

COMPONENT			SPARE PART										
Code	Description	Image	Code	Description	Components list								
VM1815A	LATERAL SUPPORTS FIXING BOLT		KVM1815A	MISS/MICRO/S4/S3 THUMB SCREW 10 PCS KIT	<table border="1"> <thead> <tr> <th>Code</th> <th>Description</th> <th>Qty</th> <th>UOM</th> </tr> </thead> <tbody> <tr> <td>VM1815A0</td> <td>LATERAL SUPPORTS FIXING BOLT</td> <td>10</td> <td>PZ</td> </tr> </tbody> </table>	Code	Description	Qty	UOM	VM1815A0	LATERAL SUPPORTS FIXING BOLT	10	PZ
Code	Description	Qty	UOM										
VM1815A0	LATERAL SUPPORTS FIXING BOLT	10	PZ										
0H3020A	MOTOR SHAFT SEALING DISC		0H3020A1	MOTOR SHAFT SEALING DISC									
0H4820A	BULB HOLDING BRACKET		0H4820A1	BULB HOLDING BRACKET									
0H3590A	SAFETY THERMOSTAT BULB FASTENER		0H3590A1	SAFETY THERMOSTAT BULB FASTENER									
GN1140A	MOTOR HOLDER GASKET		KGN1140A	5 PCS. MOTOR HOLDER GASKET KI	<table border="1"> <thead> <tr> <th>Code</th> <th>Description</th> <th>Qty</th> <th>UOM</th> </tr> </thead> <tbody> <tr> <td>GN1140A2</td> <td>MOTOR HOLDER GASKET</td> <td>5</td> <td>PZ</td> </tr> </tbody> </table>	Code	Description	Qty	UOM	GN1140A2	MOTOR HOLDER GASKET	5	PZ
Code	Description	Qty	UOM										
GN1140A2	MOTOR HOLDER GASKET	5	PZ										

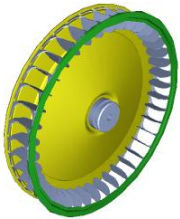
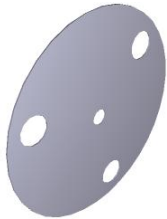
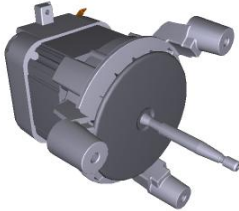

COMPONENT			SPARE PART										
Code	Description	Image	Code	Description	Components list								
0H6910A	OCTAGONAL XF OVENS PLATE COVER		0H6910A0	OCTAGONAL XF OVENS PLATE COVER									
0G1531A	ST.STEEL FAN GUARD OCT. XF023		0G1531A1	ST.STEEL FAN GUARD OCT. XF023									
0G1532A	FAN GUARD SPACER OCT. XF023		0G1532A0	FAN GUARD SPACER OCT. XF023									
0G1231A	XF023 TAINLESS STEEL FAN GUARD SPACER		0G1231A0	XF023 TAINLESS STEEL FAN GUARD SPACER									
VI1785A	CHROMIUM PLATED BRASS SCREW M6X12		KV11785A	M6X12 SCREW 20 PCS. KIT	<table border="1"> <thead> <tr> <th>Code</th> <th>Description</th> <th>Qty</th> <th>UOM</th> </tr> </thead> <tbody> <tr> <td>VI1300A0</td> <td>SCREW M6X12 T1/2T+INOX</td> <td>20</td> <td>PZ</td> </tr> </tbody> </table>	Code	Description	Qty	UOM	VI1300A0	SCREW M6X12 T1/2T+INOX	20	PZ
Code	Description	Qty	UOM										
VI1300A0	SCREW M6X12 T1/2T+INOX	20	PZ										

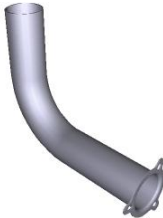
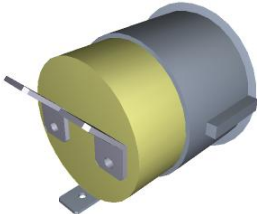
COMPONENT			SPARE PART																																										
Code	Description	Image	Code	Description	Components list																																								
VN1050A	D=196 H=32 38 BLADES STAINLESS STEEL FAN		KVN1050A	D196 H32 FAN KIT	<table border="1"> <thead> <tr> <th>Code</th> <th>Description</th> <th>Qty</th> <th>UOM</th> </tr> </thead> <tbody> <tr> <td>V11695A0</td> <td>M6X16 H6 CH10 STAINLESS STEEL NUT</td> <td>1</td> <td>PZ</td> </tr> <tr> <td>V11700A0</td> <td>18X6.4X1.5 STAINLESS STEEL FLAT WASHER</td> <td>1</td> <td>PZ</td> </tr> <tr> <td>VN1050A2</td> <td>D=196 H=32 38 BLADES STAINLESS STEEL FAN</td> <td>1</td> <td>PZ</td> </tr> <tr> <td>VN1050A2</td> <td>D=196 H=32 38 BLADES STAINLESS STEEL FAN</td> <td>1</td> <td>PZ</td> </tr> </tbody> </table>	Code	Description	Qty	UOM	V11695A0	M6X16 H6 CH10 STAINLESS STEEL NUT	1	PZ	V11700A0	18X6.4X1.5 STAINLESS STEEL FLAT WASHER	1	PZ	VN1050A2	D=196 H=32 38 BLADES STAINLESS STEEL FAN	1	PZ	VN1050A2	D=196 H=32 38 BLADES STAINLESS STEEL FAN	1	PZ																				
					Code	Description	Qty	UOM																																					
					V11695A0	M6X16 H6 CH10 STAINLESS STEEL NUT	1	PZ																																					
					V11700A0	18X6.4X1.5 STAINLESS STEEL FLAT WASHER	1	PZ																																					
VN1050A2	D=196 H=32 38 BLADES STAINLESS STEEL FAN	1	PZ																																										
VN1050A2	D=196 H=32 38 BLADES STAINLESS STEEL FAN	1	PZ																																										
0H3585A	ZINCED MOTOR GUARD PLATE L.M.		0H3585A0	ZINCED MOTOR GUARD PLATE L.M.																																									
VN1035B	LINE MISS 230 VAC MOTOR		KVN1035B	LINEMISS / LINEMICRO MOTOR KIT	<table border="1"> <thead> <tr> <th>Code</th> <th>Description</th> <th>Qty</th> <th>UOM</th> </tr> </thead> <tbody> <tr> <td>GN1270A0</td> <td>13X5.5X0.8 FLAT WASHER</td> <td>3</td> <td>PZ</td> </tr> <tr> <td>GN1546A0</td> <td>SHAFT GASKET D8</td> <td>1</td> <td>PZ</td> </tr> <tr> <td>V11695A0</td> <td>M6X16 H6 CH10 STAINLESS STEEL NUT</td> <td>1</td> <td>PZ</td> </tr> <tr> <td>V11700A0</td> <td>18X6.4X1.5 STAINLESS STEEL FLAT WASHER</td> <td>1</td> <td>PZ</td> </tr> <tr> <td>V11836A0</td> <td>M6X12 OT63 ROTOR SCRE</td> <td>3</td> <td>PZ</td> </tr> <tr> <td>VM1794A0</td> <td>250X4.8 PA66 BLACK CLAMP</td> <td>3</td> <td>PZ</td> </tr> <tr> <td>VM2103A0</td> <td>CLAMP LOCK</td> <td>3</td> <td>PZ</td> </tr> <tr> <td>VN1035B1</td> <td>LINE MISS 230 VAC MOTOR</td> <td>1</td> <td>PZ</td> </tr> <tr> <td>VN1035B1</td> <td>LINE MISS 230 VAC MOTOR</td> <td>1</td> <td>PZ</td> </tr> </tbody> </table>	Code	Description	Qty	UOM	GN1270A0	13X5.5X0.8 FLAT WASHER	3	PZ	GN1546A0	SHAFT GASKET D8	1	PZ	V11695A0	M6X16 H6 CH10 STAINLESS STEEL NUT	1	PZ	V11700A0	18X6.4X1.5 STAINLESS STEEL FLAT WASHER	1	PZ	V11836A0	M6X12 OT63 ROTOR SCRE	3	PZ	VM1794A0	250X4.8 PA66 BLACK CLAMP	3	PZ	VM2103A0	CLAMP LOCK	3	PZ	VN1035B1	LINE MISS 230 VAC MOTOR	1	PZ	VN1035B1	LINE MISS 230 VAC MOTOR	1	PZ
					Code	Description	Qty	UOM																																					
					GN1270A0	13X5.5X0.8 FLAT WASHER	3	PZ																																					
					GN1546A0	SHAFT GASKET D8	1	PZ																																					
					V11695A0	M6X16 H6 CH10 STAINLESS STEEL NUT	1	PZ																																					
					V11700A0	18X6.4X1.5 STAINLESS STEEL FLAT WASHER	1	PZ																																					
					V11836A0	M6X12 OT63 ROTOR SCRE	3	PZ																																					
					VM1794A0	250X4.8 PA66 BLACK CLAMP	3	PZ																																					
					VM2103A0	CLAMP LOCK	3	PZ																																					
					VN1035B1	LINE MISS 230 VAC MOTOR	1	PZ																																					
					VN1035B1	LINE MISS 230 VAC MOTOR	1	PZ																																					

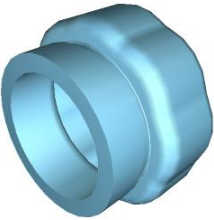
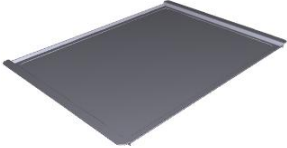
COMPONENT			SPARE PART																														
Code	Description	Image	Code	Description	Components list																												
RS1130A	D=230 3 TURNS HEATING ELEMENT		KRS1130A	2,9 KW HEATING ELEMENT KIT	<table border="1"> <thead> <tr> <th>Code</th> <th>Description</th> <th>Qty</th> <th>UOM</th> </tr> </thead> <tbody> <tr> <td>GN1327A0</td> <td>HEATING ELEMENT GASKET</td> <td>1</td> <td>PZ</td> </tr> <tr> <td>RS1130A0</td> <td>D=230 3 TURNS HEATING ELEMENT</td> <td>1</td> <td>PZ</td> </tr> <tr> <td>SL1045A0</td> <td>S53 BLACK SILICONE - 80ML CARTRIDGE</td> <td>1</td> <td>PZ</td> </tr> <tr> <td>VI1220A1</td> <td>4,2X12 TCB SELF-TAPPIN G SCREW</td> <td>5</td> <td>PZ</td> </tr> <tr> <td>VM1794A0</td> <td>250X4.8 PA66 BLACK CLAMP</td> <td>2</td> <td>PZ</td> </tr> <tr> <td>VM2103A0</td> <td>CLAMP LOCK</td> <td>2</td> <td>PZ</td> </tr> </tbody> </table>	Code	Description	Qty	UOM	GN1327A0	HEATING ELEMENT GASKET	1	PZ	RS1130A0	D=230 3 TURNS HEATING ELEMENT	1	PZ	SL1045A0	S53 BLACK SILICONE - 80ML CARTRIDGE	1	PZ	VI1220A1	4,2X12 TCB SELF-TAPPIN G SCREW	5	PZ	VM1794A0	250X4.8 PA66 BLACK CLAMP	2	PZ	VM2103A0	CLAMP LOCK	2	PZ
					Code	Description	Qty	UOM																									
					GN1327A0	HEATING ELEMENT GASKET	1	PZ																									
					RS1130A0	D=230 3 TURNS HEATING ELEMENT	1	PZ																									
					SL1045A0	S53 BLACK SILICONE - 80ML CARTRIDGE	1	PZ																									
					VI1220A1	4,2X12 TCB SELF-TAPPIN G SCREW	5	PZ																									
VM1794A0	250X4.8 PA66 BLACK CLAMP	2	PZ																														
VM2103A0	CLAMP LOCK	2	PZ																														
GRL1090B	XF023 R/L 4 75 PITCH LAT. SUPPOR		KGRL1090B	XF023 R/L 460X330 LATERAL SUPPORT KIT	<table border="1"> <thead> <tr> <th>Code</th> <th>Description</th> <th>Qty</th> <th>UOM</th> </tr> </thead> <tbody> <tr> <td>GRL1090B0</td> <td>XF023 R/L 4 75 PITCH LAT. SUPPORT</td> <td>2</td> <td>PZ</td> </tr> <tr> <td>VM1059A1</td> <td>HEAT SHRINK FILM H800</td> <td>1</td> <td>M</td> </tr> </tbody> </table>	Code	Description	Qty	UOM	GRL1090B0	XF023 R/L 4 75 PITCH LAT. SUPPORT	2	PZ	VM1059A1	HEAT SHRINK FILM H800	1	M																
					Code	Description	Qty	UOM																									
GRL1090B0	XF023 R/L 4 75 PITCH LAT. SUPPORT	2	PZ																														
VM1059A1	HEAT SHRINK FILM H800	1	M																														
TB2092A	LINE MICRO EXHAUST CHIMNEY		TB2092A0	LINE MICRO EXHAUST CHIMNEY																													
VE1480A	230V-25W LAMP SET		KVE1480A	L.MICRO LAMP KIT 230V-25W	<table border="1"> <thead> <tr> <th>Code</th> <th>Description</th> <th>Qty</th> <th>UOM</th> </tr> </thead> <tbody> <tr> <td>VE1480A0</td> <td>230V-25W LAMP SET</td> <td>1</td> <td>PZ</td> </tr> <tr> <td>VT1200A0</td> <td>L.MICRO LAMP COVER BOROSILICAT E GLASS</td> <td>1</td> <td>PZ</td> </tr> <tr> <td>VT1200A0</td> <td>L.MICRO LAMP COVER BOROSILICAT E GLASS</td> <td>1</td> <td>PZ</td> </tr> </tbody> </table>	Code	Description	Qty	UOM	VE1480A0	230V-25W LAMP SET	1	PZ	VT1200A0	L.MICRO LAMP COVER BOROSILICAT E GLASS	1	PZ	VT1200A0	L.MICRO LAMP COVER BOROSILICAT E GLASS	1	PZ												
					Code	Description	Qty	UOM																									
					VE1480A0	230V-25W LAMP SET	1	PZ																									
VT1200A0	L.MICRO LAMP COVER BOROSILICAT E GLASS	1	PZ																														
VT1200A0	L.MICRO LAMP COVER BOROSILICAT E GLASS	1	PZ																														

COMPONENT			SPARE PART																		
Code	Description	Image	Code	Description	Components list																
VT1200A	L.MICRO LAMP COVER BOROSILICATE GLASS		KVE1485A	120V-25W LAMP SET KIT	<table border="1"> <thead> <tr> <th>Code</th> <th>Description</th> <th>Qty</th> <th>UOM</th> </tr> </thead> <tbody> <tr> <td>VE1485A0</td> <td>120V-25W LAMP SET</td> <td>1</td> <td>PZ</td> </tr> <tr> <td>VT1200A0</td> <td>L.MICRO LAMP COVER BOROSILICATE GLASS</td> <td>1</td> <td>PZ</td> </tr> <tr> <td>VT1200A0</td> <td>L.MICRO LAMP COVER BOROSILICATE GLASS</td> <td>1</td> <td>PZ</td> </tr> </tbody> </table>	Code	Description	Qty	UOM	VE1485A0	120V-25W LAMP SET	1	PZ	VT1200A0	L.MICRO LAMP COVER BOROSILICATE GLASS	1	PZ	VT1200A0	L.MICRO LAMP COVER BOROSILICATE GLASS	1	PZ
					Code	Description	Qty	UOM													
			VE1485A0	120V-25W LAMP SET	1	PZ															
			VT1200A0	L.MICRO LAMP COVER BOROSILICATE GLASS	1	PZ															
VT1200A0	L.MICRO LAMP COVER BOROSILICATE GLASS	1	PZ																		
KVE1480A	L.MICRO LAMP KIT 230V-25W	<table border="1"> <thead> <tr> <th>Code</th> <th>Description</th> <th>Qty</th> <th>UOM</th> </tr> </thead> <tbody> <tr> <td>VE1480A0</td> <td>230V-25W LAMP SET</td> <td>1</td> <td>PZ</td> </tr> <tr> <td>VT1200A0</td> <td>L.MICRO LAMP COVER BOROSILICATE GLASS</td> <td>1</td> <td>PZ</td> </tr> <tr> <td>VT1200A0</td> <td>L.MICRO LAMP COVER BOROSILICATE GLASS</td> <td>1</td> <td>PZ</td> </tr> </tbody> </table>	Code	Description	Qty	UOM	VE1480A0	230V-25W LAMP SET	1	PZ	VT1200A0	L.MICRO LAMP COVER BOROSILICATE GLASS	1	PZ	VT1200A0	L.MICRO LAMP COVER BOROSILICATE GLASS	1	PZ			
		Code	Description	Qty	UOM																
VE1480A0	230V-25W LAMP SET	1	PZ																		
VT1200A0	L.MICRO LAMP COVER BOROSILICATE GLASS	1	PZ																		
VT1200A0	L.MICRO LAMP COVER BOROSILICATE GLASS	1	PZ																		
ATG305	TRAY 460X330 FLAT ALUMINIUM		ATG3050	TRAY 460X330 FLAT ALUMINIUM																	
GN1235A	LINEMICRO ANNA XF023 DOOR GASKE		KGN1235A	LINEMICRO XF023 DOOR GASKET KIT	<table border="1"> <thead> <tr> <th>Code</th> <th>Description</th> <th>Qty</th> <th>UOM</th> </tr> </thead> <tbody> <tr> <td>GN1235A0</td> <td>LINEMICRO ANNA XF023 DOOR GASKE</td> <td>1</td> <td>PZ</td> </tr> </tbody> </table>	Code	Description	Qty	UOM	GN1235A0	LINEMICRO ANNA XF023 DOOR GASKE	1	PZ								
					Code	Description	Qty	UOM													
GN1235A0	LINEMICRO ANNA XF023 DOOR GASKE	1	PZ																		



ASM1521A/0.D01 - External cover

FRONT



ASM1521A/0.D01 - External cover

REAR

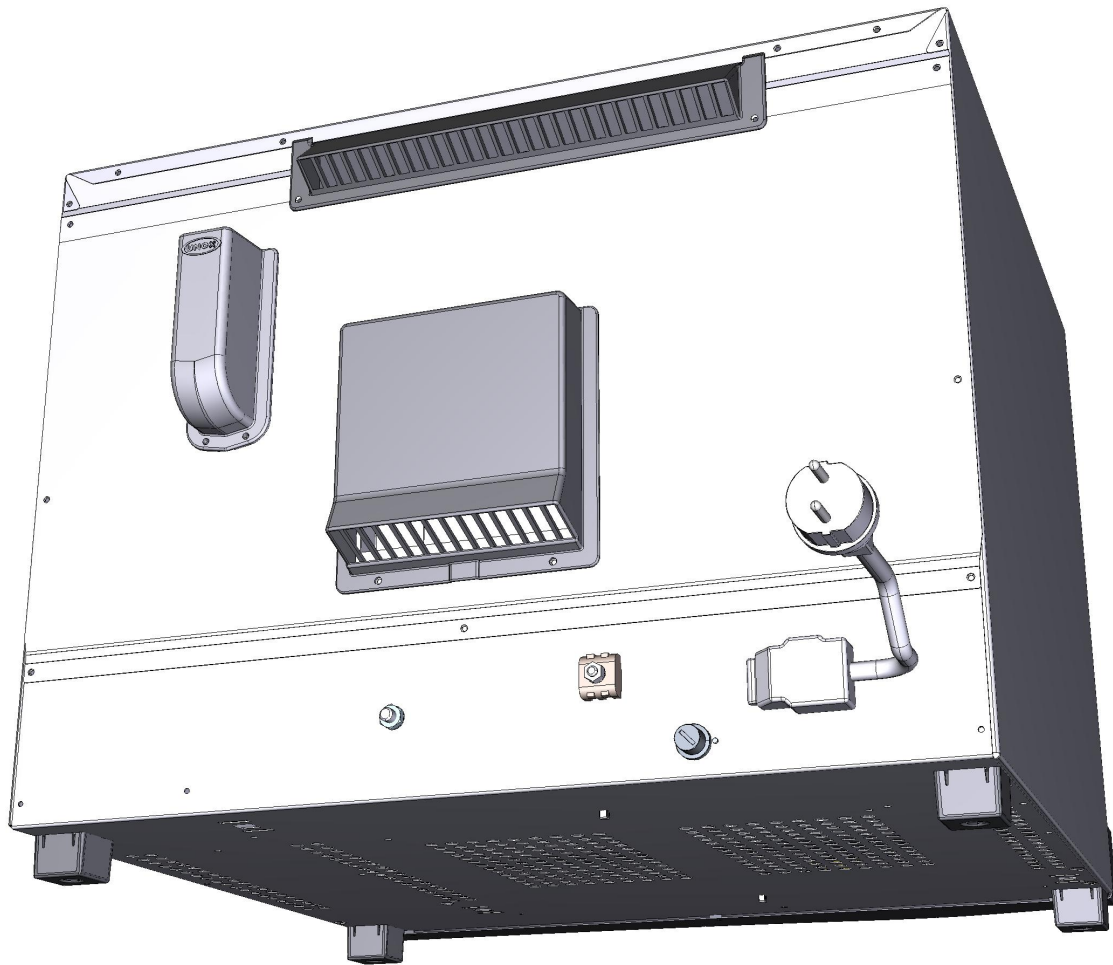

COMPONENT			SPARE PART																		
Code	Description	Image	Code	Description	Components list																
VM1951A	IP CHIMNEY COVER		KVM1065A	LINE MISS EXHAUST CHIMNEY COVER	<table border="1"> <thead> <tr> <th>Code</th> <th>Description</th> <th>Qty</th> <th>UOM</th> </tr> </thead> <tbody> <tr> <td>VM1065A0</td> <td>L.M. EXHAUST CHIMNEY COVER</td> <td>1</td> <td>PZ</td> </tr> </tbody> </table>	Code	Description	Qty	UOM	VM1065A0	L.M. EXHAUST CHIMNEY COVER	1	PZ								
Code	Description	Qty	UOM																		
VM1065A0	L.M. EXHAUST CHIMNEY COVER	1	PZ																		
PD1001A	35X35 H26 GREY PLASTIC+RUBBER FOOT		KPD1001A	35X35 H26 FEET 4PCS KIT	<table border="1"> <thead> <tr> <th>Code</th> <th>Description</th> <th>Qty</th> <th>UOM</th> </tr> </thead> <tbody> <tr> <td>PD1001A0</td> <td>35X35 H26 GREY PLASTIC+RUBBER FOOT</td> <td>4</td> <td>PZ</td> </tr> </tbody> </table>	Code	Description	Qty	UOM	PD1001A0	35X35 H26 GREY PLASTIC+RUBBER FOOT	4	PZ								
Code	Description	Qty	UOM																		
PD1001A0	35X35 H26 GREY PLASTIC+RUBBER FOOT	4	PZ																		
VM1750A	BRASS COMB CLAM		KVM1750A	COMB TERMINAL BLOCK KIT	<table border="1"> <thead> <tr> <th>Code</th> <th>Description</th> <th>Qty</th> <th>UOM</th> </tr> </thead> <tbody> <tr> <td>VM1750A0</td> <td>BRASS COMB CLAMP</td> <td>1</td> <td>PZ</td> </tr> </tbody> </table>	Code	Description	Qty	UOM	VM1750A0	BRASS COMB CLAMP	1	PZ								
Code	Description	Qty	UOM																		
VM1750A0	BRASS COMB CLAMP	1	PZ																		
VM1952A	IP MOTOR COVER		KVM1952A	XF/XFT/XAF/XAFT MOTOR COVER KIT	<table border="1"> <thead> <tr> <th>Code</th> <th>Description</th> <th>Qty</th> <th>UOM</th> </tr> </thead> <tbody> <tr> <td>VI1220A1</td> <td>4,2X12 TCB SELF-TAPPING SCREW</td> <td>2</td> <td>PZ</td> </tr> <tr> <td>VM1952A0</td> <td>IP MOTOR COVER</td> <td>1</td> <td>PZ</td> </tr> <tr> <td>VM1952A1</td> <td>WATER PROTECTION MOTOR COVE</td> <td>1</td> <td>PZ</td> </tr> </tbody> </table>	Code	Description	Qty	UOM	VI1220A1	4,2X12 TCB SELF-TAPPING SCREW	2	PZ	VM1952A0	IP MOTOR COVER	1	PZ	VM1952A1	WATER PROTECTION MOTOR COVE	1	PZ
Code	Description	Qty	UOM																		
VI1220A1	4,2X12 TCB SELF-TAPPING SCREW	2	PZ																		
VM1952A0	IP MOTOR COVER	1	PZ																		
VM1952A1	WATER PROTECTION MOTOR COVE	1	PZ																		
MR1000A	CABLE 3X1,5 H07RN-F MT1,5+K2/3+SCHUK		KMR1000A	KIT CABLE 3X1,5 H07RN-F +K2/3+SCHUKO	<table border="1"> <thead> <tr> <th>Code</th> <th>Description</th> <th>Qty</th> <th>UOM</th> </tr> </thead> <tbody> <tr> <td>MR1000A0</td> <td>CABLE 3X1,5 H07RN-F MT1,5+K2/3+SCHUKO</td> <td>1</td> <td>PZ</td> </tr> </tbody> </table>	Code	Description	Qty	UOM	MR1000A0	CABLE 3X1,5 H07RN-F MT1,5+K2/3+SCHUKO	1	PZ								
Code	Description	Qty	UOM																		
MR1000A0	CABLE 3X1,5 H07RN-F MT1,5+K2/3+SCHUKO	1	PZ																		





COMPONENT			SPARE PART																						
Code	Description	Image	Code	Description	Components list																				
0D2232A	LINEMICRO XF023 OUTER OCTAGONAL CASIN		0D2232A0	LINEMICRO XF023 OUTER OCTAGONAL CASIN																					
0E1175B	L.MICRO LISA-ANNA EXTERNAL BOTTOM PANEL		0E1175B1	L.MICRO LISA-ANNA EXTERNAL BOTTOM PANEL																					
0F1422A	LINEMICRO XF023 IP BACK PANEL																								
ED1070A	78X33 UNOX LOGO STICKER		KED1070A	UNOX LOGO STICKER 10 PCS. KI	<table border="1"> <thead> <tr> <th>Code</th> <th>Description</th> <th>Qty</th> <th>UOM</th> </tr> </thead> <tbody> <tr> <td>ED1070A0</td> <td>78X33 UNOX LOGO STICKE</td> <td>10</td> <td>PZ</td> </tr> </tbody> </table>	Code	Description	Qty	UOM	ED1070A0	78X33 UNOX LOGO STICKE	10	PZ												
Code	Description	Qty	UOM																						
ED1070A0	78X33 UNOX LOGO STICKE	10	PZ																						
VE1170A	D16 OPAQUE NICKEL ELLIPTICAL SUPPORT		KVE0108A	XP ON-OFF SWITCH KIT	<table border="1"> <thead> <tr> <th>Code</th> <th>Description</th> <th>Qty</th> <th>UOM</th> </tr> </thead> <tbody> <tr> <td>VE1170A0</td> <td>D16 OPAQUE NICKEL ELLIPTICAL SUPPORT</td> <td>1</td> <td>PZ</td> </tr> <tr> <td>VE1561A0</td> <td>NA/NA BIPOLEAR SWITCH</td> <td>1</td> <td>PZ</td> </tr> <tr> <td>VM1761A0</td> <td>D16 BLACK ELLIPTICAL SUPPORT</td> <td>1</td> <td>PZ</td> </tr> <tr> <td>VM1776A0</td> <td>GOLD "0-1" MATT SILVER KEY</td> <td>1</td> <td>PZ</td> </tr> </tbody> </table>	Code	Description	Qty	UOM	VE1170A0	D16 OPAQUE NICKEL ELLIPTICAL SUPPORT	1	PZ	VE1561A0	NA/NA BIPOLEAR SWITCH	1	PZ	VM1761A0	D16 BLACK ELLIPTICAL SUPPORT	1	PZ	VM1776A0	GOLD "0-1" MATT SILVER KEY	1	PZ
Code	Description	Qty	UOM																						
VE1170A0	D16 OPAQUE NICKEL ELLIPTICAL SUPPORT	1	PZ																						
VE1561A0	NA/NA BIPOLEAR SWITCH	1	PZ																						
VM1761A0	D16 BLACK ELLIPTICAL SUPPORT	1	PZ																						
VM1776A0	GOLD "0-1" MATT SILVER KEY	1	PZ																						

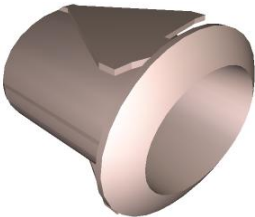

COMPONENT			SPARE PART																										
Code	Description	Image	Code	Description	Components list																								
VE1170A	D16 OPAQUE NICKEL ELLIPTICAL SUPPORT		KLP1014A	SINUSOID LED LIGHT+COVER+SUP PORT KIT	<table border="1"> <thead> <tr> <th>Code</th> <th>Description</th> <th>Qty</th> <th>UOM</th> </tr> </thead> <tbody> <tr> <td>VE1170A0</td> <td>D16 OPAQUE NICKEL ELLIPTICAL SUPPORT</td> <td>2</td> <td>PZ</td> </tr> <tr> <td>VE1535A1</td> <td>230V WHITE LED</td> <td>2</td> <td>PZ</td> </tr> <tr> <td>VE1585A0</td> <td>BLUE LIGHT COVER GOLD SINUSOID</td> <td>2</td> <td>PZ</td> </tr> <tr> <td>VM1762A0</td> <td>INNER LAMP SUPPORT</td> <td>2</td> <td>PZ</td> </tr> <tr> <td>VM2009A0</td> <td>ELLIPTICAL SILVER SUPPORT D16</td> <td>1</td> <td>PZ</td> </tr> </tbody> </table>	Code	Description	Qty	UOM	VE1170A0	D16 OPAQUE NICKEL ELLIPTICAL SUPPORT	2	PZ	VE1535A1	230V WHITE LED	2	PZ	VE1585A0	BLUE LIGHT COVER GOLD SINUSOID	2	PZ	VM1762A0	INNER LAMP SUPPORT	2	PZ	VM2009A0	ELLIPTICAL SILVER SUPPORT D16	1	PZ
					Code	Description	Qty	UOM																					
					VE1170A0	D16 OPAQUE NICKEL ELLIPTICAL SUPPORT	2	PZ																					
					VE1535A1	230V WHITE LED	2	PZ																					
			VE1585A0	BLUE LIGHT COVER GOLD SINUSOID	2	PZ																							
			VM1762A0	INNER LAMP SUPPORT	2	PZ																							
			VM2009A0	ELLIPTICAL SILVER SUPPORT D16	1	PZ																							
			KLP1012A	BLUE LIGHT THERMOMETER KIT	<table border="1"> <thead> <tr> <th>Code</th> <th>Description</th> <th>Qty</th> <th>UOM</th> </tr> </thead> <tbody> <tr> <td>VE1170A0</td> <td>D16 OPAQUE NICKEL ELLIPTICAL SUPPORT</td> <td>1</td> <td>PZ</td> </tr> <tr> <td>VE1530A0</td> <td>GOLD THERMOMETE R BLUE LIGHT COVER</td> <td>1</td> <td>PZ</td> </tr> <tr> <td>VE1535A1</td> <td>230V WHITE LED</td> <td>1</td> <td>PZ</td> </tr> <tr> <td>VM1762A0</td> <td>INNER LAMP SUPPORT</td> <td>1</td> <td>PZ</td> </tr> </tbody> </table>	Code	Description	Qty	UOM	VE1170A0	D16 OPAQUE NICKEL ELLIPTICAL SUPPORT	1	PZ	VE1530A0	GOLD THERMOMETE R BLUE LIGHT COVER	1	PZ	VE1535A1	230V WHITE LED	1	PZ	VM1762A0	INNER LAMP SUPPORT	1	PZ				
					Code	Description	Qty	UOM																					
					VE1170A0	D16 OPAQUE NICKEL ELLIPTICAL SUPPORT	1	PZ																					
			VE1530A0	GOLD THERMOMETE R BLUE LIGHT COVER	1	PZ																							
			VE1535A1	230V WHITE LED	1	PZ																							
VM1762A0	INNER LAMP SUPPORT	1	PZ																										
KLP1011A	THERMOMETER LED LIGHT+COVER+SUP PORT KIT	<table border="1"> <thead> <tr> <th>Code</th> <th>Description</th> <th>Qty</th> <th>UOM</th> </tr> </thead> <tbody> <tr> <td>VE1170A0</td> <td>D16 OPAQUE NICKEL ELLIPTICAL SUPPORT</td> <td>1</td> <td>PZ</td> </tr> <tr> <td>VE1530A0</td> <td>GOLD THERMOMETE R BLUE LIGHT COVER</td> <td>1</td> <td>PZ</td> </tr> <tr> <td>VE1535A1</td> <td>230V WHITE LED</td> <td>1</td> <td>PZ</td> </tr> <tr> <td>VM1762A0</td> <td>INNER LAMP SUPPORT</td> <td>1</td> <td>PZ</td> </tr> </tbody> </table>	Code	Description	Qty	UOM	VE1170A0	D16 OPAQUE NICKEL ELLIPTICAL SUPPORT	1	PZ	VE1530A0	GOLD THERMOMETE R BLUE LIGHT COVER	1	PZ	VE1535A1	230V WHITE LED	1	PZ	VM1762A0	INNER LAMP SUPPORT	1	PZ							
		Code	Description	Qty	UOM																								
		VE1170A0	D16 OPAQUE NICKEL ELLIPTICAL SUPPORT	1	PZ																								
		VE1530A0	GOLD THERMOMETE R BLUE LIGHT COVER	1	PZ																								
VE1535A1	230V WHITE LED	1	PZ																										
VM1762A0	INNER LAMP SUPPORT	1	PZ																										
KLP1010A	THERMOSTAT GREEN LIGHT KIT	<table border="1"> <thead> <tr> <th>Code</th> <th>Description</th> <th>Qty</th> <th>UOM</th> </tr> </thead> <tbody> <tr> <td>VE1170A0</td> <td>D16 OPAQUE NICKEL ELLIPTICAL SUPPORT</td> <td>1</td> <td>PZ</td> </tr> <tr> <td>VE1535A1</td> <td>230V WHITE LED</td> <td>1</td> <td>PZ</td> </tr> <tr> <td>VM1762A0</td> <td>INNER LAMP SUPPORT</td> <td>1</td> <td>PZ</td> </tr> <tr> <td>VM1764A0</td> <td>GREEN PILOT WITH GOLD THERMOMETE</td> <td>1</td> <td>PZ</td> </tr> </tbody> </table>	Code	Description	Qty	UOM	VE1170A0	D16 OPAQUE NICKEL ELLIPTICAL SUPPORT	1	PZ	VE1535A1	230V WHITE LED	1	PZ	VM1762A0	INNER LAMP SUPPORT	1	PZ	VM1764A0	GREEN PILOT WITH GOLD THERMOMETE	1	PZ							
		Code	Description	Qty	UOM																								
		VE1170A0	D16 OPAQUE NICKEL ELLIPTICAL SUPPORT	1	PZ																								
		VE1535A1	230V WHITE LED	1	PZ																								
VM1762A0	INNER LAMP SUPPORT	1	PZ																										
VM1764A0	GREEN PILOT WITH GOLD THERMOMETE	1	PZ																										

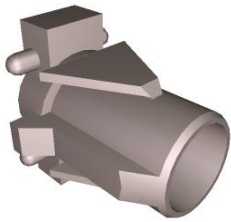
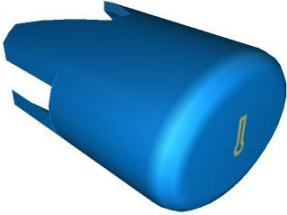

COMPONENT			SPARE PART																																						
Code	Description	Image	Code	Description	Components list																																				
VM1762A	INNER LAMP SUPPORT		KVM1762A	LAMP INTERNAL SUPPORT KIT	<table border="1"> <thead> <tr> <th>Code</th> <th>Description</th> <th>Qty</th> <th>UOM</th> </tr> </thead> <tbody> <tr> <td>VM1762A0</td> <td>INNER LAMP SUPPORT</td> <td>1</td> <td>PZ</td> </tr> </tbody> </table>	Code	Description	Qty	UOM	VM1762A0	INNER LAMP SUPPORT	1	PZ																												
Code	Description	Qty	UOM																																						
VM1762A0	INNER LAMP SUPPORT	1	PZ																																						
VE1530A	GOLD THERMOMETER BLUE LIGHT COVER		KLP1012A	BLUE LIGHT THERMOMETER KIT	<table border="1"> <thead> <tr> <th>Code</th> <th>Description</th> <th>Qty</th> <th>UOM</th> </tr> </thead> <tbody> <tr> <td>VE1170A0</td> <td>D16 OPAQUE NICKEL ELLIPTICAL SUPPORT</td> <td>1</td> <td>PZ</td> </tr> <tr> <td>VE1530A0</td> <td>GOLD THERMOMETE R BLUE LIGHT COVER</td> <td>1</td> <td>PZ</td> </tr> <tr> <td>VE1535A1</td> <td>230V WHITE LED</td> <td>1</td> <td>PZ</td> </tr> <tr> <td>VM1762A0</td> <td>INNER LAMP SUPPORT</td> <td>1</td> <td>PZ</td> </tr> </tbody> </table>	Code	Description	Qty	UOM	VE1170A0	D16 OPAQUE NICKEL ELLIPTICAL SUPPORT	1	PZ	VE1530A0	GOLD THERMOMETE R BLUE LIGHT COVER	1	PZ	VE1535A1	230V WHITE LED	1	PZ	VM1762A0	INNER LAMP SUPPORT	1	PZ																
Code	Description	Qty	UOM																																						
VE1170A0	D16 OPAQUE NICKEL ELLIPTICAL SUPPORT	1	PZ																																						
VE1530A0	GOLD THERMOMETE R BLUE LIGHT COVER	1	PZ																																						
VE1535A1	230V WHITE LED	1	PZ																																						
VM1762A0	INNER LAMP SUPPORT	1	PZ																																						
VE1545A	12V WHITE LED LIGHT		KVE1545A	12V WHITE LED 10 PCS. KIT	<table border="1"> <thead> <tr> <th>Code</th> <th>Description</th> <th>Qty</th> <th>UOM</th> </tr> </thead> <tbody> <tr> <td>VE1545A0</td> <td>12V WHITE LED LIGHT</td> <td>10</td> <td>PZ</td> </tr> </tbody> </table>	Code	Description	Qty	UOM	VE1545A0	12V WHITE LED LIGHT	10	PZ																												
Code	Description	Qty	UOM																																						
VE1545A0	12V WHITE LED LIGHT	10	PZ																																						
VE1535A	230V WHITE LED		<p>KVE1535A</p> <p>KVE0105A</p> <p>KVE0104A</p>	<p>LED LIGHT 1 PC. KIT</p> <p>CLOUD LED LIGHT+COVER+SUPPORT KIT</p> <p>NEUTRAL GREEN LIGHT KIT</p>	<table border="1"> <thead> <tr> <th>Code</th> <th>Description</th> <th>Qty</th> <th>UOM</th> </tr> </thead> <tbody> <tr> <td>VE1535A1</td> <td>230V WHITE LED</td> <td>1</td> <td>PZ</td> </tr> </tbody> </table> <table border="1"> <thead> <tr> <th>Code</th> <th>Description</th> <th>Qty</th> <th>UOM</th> </tr> </thead> <tbody> <tr> <td>VE1535A1</td> <td>230V WHITE LED</td> <td>1</td> <td>PZ</td> </tr> <tr> <td>VM1761A0</td> <td>D16 BLACK ELLIPTICAL SUPPORT</td> <td>1</td> <td>PZ</td> </tr> <tr> <td>VM1762A0</td> <td>INNER LAMP SUPPORT</td> <td>1</td> <td>PZ</td> </tr> <tr> <td>VM1903A0</td> <td>GREEN PILOT WITH GOLD "CLOUD"</td> <td>1</td> <td>PZ</td> </tr> </tbody> </table> <table border="1"> <thead> <tr> <th>Code</th> <th>Description</th> <th>Qty</th> <th>UOM</th> </tr> </thead> <tbody> <tr> <td>VE1535A1</td> <td>230V WHITE LED</td> <td>1</td> <td>PZ</td> </tr> </tbody> </table>	Code	Description	Qty	UOM	VE1535A1	230V WHITE LED	1	PZ	Code	Description	Qty	UOM	VE1535A1	230V WHITE LED	1	PZ	VM1761A0	D16 BLACK ELLIPTICAL SUPPORT	1	PZ	VM1762A0	INNER LAMP SUPPORT	1	PZ	VM1903A0	GREEN PILOT WITH GOLD "CLOUD"	1	PZ	Code	Description	Qty	UOM	VE1535A1	230V WHITE LED	1	PZ
Code	Description	Qty	UOM																																						
VE1535A1	230V WHITE LED	1	PZ																																						
Code	Description	Qty	UOM																																						
VE1535A1	230V WHITE LED	1	PZ																																						
VM1761A0	D16 BLACK ELLIPTICAL SUPPORT	1	PZ																																						
VM1762A0	INNER LAMP SUPPORT	1	PZ																																						
VM1903A0	GREEN PILOT WITH GOLD "CLOUD"	1	PZ																																						
Code	Description	Qty	UOM																																						
VE1535A1	230V WHITE LED	1	PZ																																						



COMPONENT			SPARE PART																						
Code	Description	Image	Code	Description	Components list																				
VE1535A	230V WHITE LED		KVE0104A	NEUTRAL GREEN LIGHT KIT	<table border="1"> <thead> <tr> <th>Code</th> <th>Description</th> <th>Qty</th> <th>UOM</th> </tr> </thead> <tbody> <tr> <td>VM1761A0</td> <td>D16 BLACK ELLIPTICAL SUPPORT</td> <td>1</td> <td>PZ</td> </tr> <tr> <td>VM1762A0</td> <td>INNER LAMP SUPPORT</td> <td>1</td> <td>PZ</td> </tr> <tr> <td>VM1902A0</td> <td>NEUTRAL GREEN PLASTIC COVER FOR</td> <td>1</td> <td>PZ</td> </tr> </tbody> </table>	Code	Description	Qty	UOM	VM1761A0	D16 BLACK ELLIPTICAL SUPPORT	1	PZ	VM1762A0	INNER LAMP SUPPORT	1	PZ	VM1902A0	NEUTRAL GREEN PLASTIC COVER FOR	1	PZ				
			Code	Description	Qty	UOM																			
			VM1761A0	D16 BLACK ELLIPTICAL SUPPORT	1	PZ																			
			VM1762A0	INNER LAMP SUPPORT	1	PZ																			
			VM1902A0	NEUTRAL GREEN PLASTIC COVER FOR	1	PZ																			
			KVE0102A	GOLDEN FLAME LIGHT COVER KIT	<table border="1"> <thead> <tr> <th>Code</th> <th>Description</th> <th>Qty</th> <th>UOM</th> </tr> </thead> <tbody> <tr> <td>VE1535A1</td> <td>230V WHITE LED</td> <td>1</td> <td>PZ</td> </tr> <tr> <td>VM1761A0</td> <td>D16 BLACK ELLIPTICAL SUPPORT</td> <td>1</td> <td>PZ</td> </tr> <tr> <td>VM1762A0</td> <td>INNER LAMP SUPPORT</td> <td>1</td> <td>PZ</td> </tr> <tr> <td>VM1767A0</td> <td>GREEN PILOT LIGHT W/ GOLD FLAME</td> <td>1</td> <td>PZ</td> </tr> </tbody> </table>	Code	Description	Qty	UOM	VE1535A1	230V WHITE LED	1	PZ	VM1761A0	D16 BLACK ELLIPTICAL SUPPORT	1	PZ	VM1762A0	INNER LAMP SUPPORT	1	PZ	VM1767A0	GREEN PILOT LIGHT W/ GOLD FLAME	1	PZ
			Code	Description	Qty	UOM																			
			VE1535A1	230V WHITE LED	1	PZ																			
			VM1761A0	D16 BLACK ELLIPTICAL SUPPORT	1	PZ																			
			VM1762A0	INNER LAMP SUPPORT	1	PZ																			
			VM1767A0	GREEN PILOT LIGHT W/ GOLD FLAME	1	PZ																			
			KVE0101A	SINUSOID LIGHT GREEN COVER KIT	<table border="1"> <thead> <tr> <th>Code</th> <th>Description</th> <th>Qty</th> <th>UOM</th> </tr> </thead> <tbody> <tr> <td>VE1535A1</td> <td>230V WHITE LED</td> <td>1</td> <td>PZ</td> </tr> <tr> <td>VM1761A0</td> <td>D16 BLACK ELLIPTICAL SUPPORT</td> <td>1</td> <td>PZ</td> </tr> <tr> <td>VM1762A0</td> <td>INNER LAMP SUPPORT</td> <td>1</td> <td>PZ</td> </tr> <tr> <td>VM1765A0</td> <td>GREEN PILOT WITH GOLD SINUSOIDE</td> <td>1</td> <td>PZ</td> </tr> </tbody> </table>	Code	Description	Qty	UOM	VE1535A1	230V WHITE LED	1	PZ	VM1761A0	D16 BLACK ELLIPTICAL SUPPORT	1	PZ	VM1762A0	INNER LAMP SUPPORT	1	PZ	VM1765A0	GREEN PILOT WITH GOLD SINUSOIDE	1	PZ
Code	Description	Qty	UOM																						
VE1535A1	230V WHITE LED	1	PZ																						
VM1761A0	D16 BLACK ELLIPTICAL SUPPORT	1	PZ																						
VM1762A0	INNER LAMP SUPPORT	1	PZ																						
VM1765A0	GREEN PILOT WITH GOLD SINUSOIDE	1	PZ																						
KVE0100A	THERMOMETER LIGHT COVER KIT	<table border="1"> <thead> <tr> <th>Code</th> <th>Description</th> <th>Qty</th> <th>UOM</th> </tr> </thead> <tbody> <tr> <td>VE1530A0</td> <td>GOLD THERMOMETE R BLUE LIGHT COVER</td> <td>1</td> <td>PZ</td> </tr> <tr> <td>VE1535A1</td> <td>230V WHITE LED</td> <td>1</td> <td>PZ</td> </tr> <tr> <td>VM1761A0</td> <td>D16 BLACK ELLIPTICAL SUPPORT</td> <td>1</td> <td>PZ</td> </tr> <tr> <td>VM1762A0</td> <td>INNER LAMP SUPPORT</td> <td>1</td> <td>PZ</td> </tr> </tbody> </table>	Code	Description	Qty	UOM	VE1530A0	GOLD THERMOMETE R BLUE LIGHT COVER	1	PZ	VE1535A1	230V WHITE LED	1	PZ	VM1761A0	D16 BLACK ELLIPTICAL SUPPORT	1	PZ	VM1762A0	INNER LAMP SUPPORT	1	PZ			
Code	Description	Qty	UOM																						
VE1530A0	GOLD THERMOMETE R BLUE LIGHT COVER	1	PZ																						
VE1535A1	230V WHITE LED	1	PZ																						
VM1761A0	D16 BLACK ELLIPTICAL SUPPORT	1	PZ																						
VM1762A0	INNER LAMP SUPPORT	1	PZ																						
KVE0011A	XP KNOBS AND LIGHTS KIT	<table border="1"> <thead> <tr> <th>Code</th> <th>Description</th> <th>Qty</th> <th>UOM</th> </tr> </thead> <tbody> <tr> <td>MN1105A0</td> <td>120-400C XP THERMOSTAT KNOB</td> <td>1</td> <td>PZ</td> </tr> <tr> <td>MN1110A0</td> <td>XP NEUTRAL INDEX DIAL</td> <td>1</td> <td>PZ</td> </tr> </tbody> </table>	Code	Description	Qty	UOM	MN1105A0	120-400C XP THERMOSTAT KNOB	1	PZ	MN1110A0	XP NEUTRAL INDEX DIAL	1	PZ											
Code	Description	Qty	UOM																						
MN1105A0	120-400C XP THERMOSTAT KNOB	1	PZ																						
MN1110A0	XP NEUTRAL INDEX DIAL	1	PZ																						





COMPONENT			SPARE PART																																			
Code	Description	Image	Code	Description	Components list																																	
VE1535A	230V WHITE LED		KVE0011A	XP KNOBS AND LIGHTS KIT	<table border="1"> <thead> <tr> <th>Code</th> <th>Description</th> <th>Qty</th> <th>UOM</th> </tr> </thead> <tbody> <tr> <td>VE1530A0</td> <td>GOLD THERMOMETE R BLUE LIGHT COVER</td> <td>1</td> <td>PZ</td> </tr> <tr> <td>VE1535A1</td> <td>230V WHITE LED</td> <td>1</td> <td>PZ</td> </tr> <tr> <td>VE1561A0</td> <td>NA/NA BIPOLAR SWITCH</td> <td>1</td> <td>PZ</td> </tr> <tr> <td>VM1761A0</td> <td>D16 BLACK ELLIPTICAL SUPPORT</td> <td>2</td> <td>PZ</td> </tr> <tr> <td>VM1762A0</td> <td>INNER LAMP SUPPORT</td> <td>1</td> <td>PZ</td> </tr> <tr> <td>VM1776A0</td> <td>GOLD "0-1" MATT SILVER KEY</td> <td>1</td> <td>PZ</td> </tr> </tbody> </table>	Code	Description	Qty	UOM	VE1530A0	GOLD THERMOMETE R BLUE LIGHT COVER	1	PZ	VE1535A1	230V WHITE LED	1	PZ	VE1561A0	NA/NA BIPOLAR SWITCH	1	PZ	VM1761A0	D16 BLACK ELLIPTICAL SUPPORT	2	PZ	VM1762A0	INNER LAMP SUPPORT	1	PZ	VM1776A0	GOLD "0-1" MATT SILVER KEY	1	PZ					
			Code	Description	Qty	UOM																																
			VE1530A0	GOLD THERMOMETE R BLUE LIGHT COVER	1	PZ																																
VE1535A1	230V WHITE LED	1	PZ																																			
VE1561A0	NA/NA BIPOLAR SWITCH	1	PZ																																			
VM1761A0	D16 BLACK ELLIPTICAL SUPPORT	2	PZ																																			
VM1762A0	INNER LAMP SUPPORT	1	PZ																																			
VM1776A0	GOLD "0-1" MATT SILVER KEY	1	PZ																																			
KVE0008A	XL PILOT BLUE LIGHTS KIT	<table border="1"> <thead> <tr> <th>Code</th> <th>Description</th> <th>Qty</th> <th>UOM</th> </tr> </thead> <tbody> <tr> <td>VE1530A0</td> <td>GOLD THERMOMETE R BLUE LIGHT COVER</td> <td>1</td> <td>PZ</td> </tr> <tr> <td>VE1535A1</td> <td>230V WHITE LED</td> <td>1</td> <td>PZ</td> </tr> <tr> <td>VE1561A0</td> <td>NA/NA BIPOLAR SWITCH</td> <td>1</td> <td>PZ</td> </tr> <tr> <td>VE1562A0</td> <td>UNIPOLAR NA PUSH BUTTO</td> <td>1</td> <td>PZ</td> </tr> <tr> <td>VM1761A0</td> <td>D16 BLACK ELLIPTICAL SUPPORT</td> <td>3</td> <td>PZ</td> </tr> <tr> <td>VM1762A0</td> <td>INNER LAMP SUPPORT</td> <td>1</td> <td>PZ</td> </tr> <tr> <td>VM1775A0</td> <td>OPAQUE SILVER KEY WITH GOLD "CLOUD"</td> <td>1</td> <td>PZ</td> </tr> <tr> <td>VM1776A0</td> <td>GOLD "0-1" MATT SILVER KEY</td> <td>1</td> <td>PZ</td> </tr> </tbody> </table>	Code	Description	Qty	UOM	VE1530A0	GOLD THERMOMETE R BLUE LIGHT COVER	1	PZ	VE1535A1	230V WHITE LED	1	PZ	VE1561A0	NA/NA BIPOLAR SWITCH	1	PZ	VE1562A0	UNIPOLAR NA PUSH BUTTO	1	PZ	VM1761A0	D16 BLACK ELLIPTICAL SUPPORT	3	PZ	VM1762A0	INNER LAMP SUPPORT	1	PZ	VM1775A0	OPAQUE SILVER KEY WITH GOLD "CLOUD"	1	PZ	VM1776A0	GOLD "0-1" MATT SILVER KEY	1	PZ
Code	Description	Qty	UOM																																			
VE1530A0	GOLD THERMOMETE R BLUE LIGHT COVER	1	PZ																																			
VE1535A1	230V WHITE LED	1	PZ																																			
VE1561A0	NA/NA BIPOLAR SWITCH	1	PZ																																			
VE1562A0	UNIPOLAR NA PUSH BUTTO	1	PZ																																			
VM1761A0	D16 BLACK ELLIPTICAL SUPPORT	3	PZ																																			
VM1762A0	INNER LAMP SUPPORT	1	PZ																																			
VM1775A0	OPAQUE SILVER KEY WITH GOLD "CLOUD"	1	PZ																																			
VM1776A0	GOLD "0-1" MATT SILVER KEY	1	PZ																																			
KVE0007A	XF-XG LED AND LED COVERS KIT	<table border="1"> <thead> <tr> <th>Code</th> <th>Description</th> <th>Qty</th> <th>UOM</th> </tr> </thead> <tbody> <tr> <td>VE1530A0</td> <td>GOLD THERMOMETE R BLUE LIGHT COVER</td> <td>1</td> <td>PZ</td> </tr> <tr> <td>VE1535A1</td> <td>230V WHITE LED</td> <td>1</td> <td>PZ</td> </tr> <tr> <td>VE1562A0</td> <td>UNIPOLAR NA PUSH BUTTO</td> <td>1</td> <td>PZ</td> </tr> <tr> <td>VE1585A0</td> <td>BLUE LIGHT COVER GOLD SINUSOID</td> <td>1</td> <td>PZ</td> </tr> </tbody> </table>	Code	Description	Qty	UOM	VE1530A0	GOLD THERMOMETE R BLUE LIGHT COVER	1	PZ	VE1535A1	230V WHITE LED	1	PZ	VE1562A0	UNIPOLAR NA PUSH BUTTO	1	PZ	VE1585A0	BLUE LIGHT COVER GOLD SINUSOID	1	PZ																
Code	Description	Qty	UOM																																			
VE1530A0	GOLD THERMOMETE R BLUE LIGHT COVER	1	PZ																																			
VE1535A1	230V WHITE LED	1	PZ																																			
VE1562A0	UNIPOLAR NA PUSH BUTTO	1	PZ																																			
VE1585A0	BLUE LIGHT COVER GOLD SINUSOID	1	PZ																																			



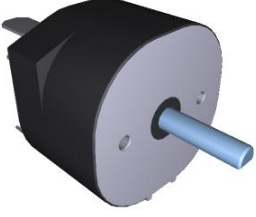
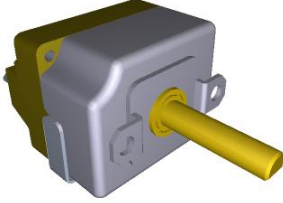

COMPONENT			SPARE PART																																		
Code	Description	Image	Code	Description	Components list																																
VE1535A	230V WHITE LED		KVE0007A	XF-XG LED AND LED COVERS KIT	<table border="1"> <thead> <tr> <th>Code</th> <th>Description</th> <th>Qty</th> <th>UOM</th> </tr> </thead> <tbody> <tr> <td>VM1761A0</td> <td>D16 BLACK ELLIPTICAL SUPPORT</td> <td>5</td> <td>PZ</td> </tr> <tr> <td>VM1762A0</td> <td>INNER LAMP SUPPORT</td> <td>4</td> <td>PZ</td> </tr> <tr> <td>VM1767A0</td> <td>GREEN PILOT LIGHT W/ GOLD FLAME</td> <td>1</td> <td>PZ</td> </tr> <tr> <td>VM1774A0</td> <td>SILVER OPAQUE KEY W/ GOLD FLAME</td> <td>1</td> <td>PZ</td> </tr> <tr> <td>VM1775A0</td> <td>OPAQUE SILVER KEY WITH GOLD "CLOUD"</td> <td>1</td> <td>PZ</td> </tr> <tr> <td>VM1902A0</td> <td>NEUTRAL GREEN PLASTIC COVER FOR</td> <td>1</td> <td>PZ</td> </tr> <tr> <td>VM1903A0</td> <td>GREEN PILOT WITH GOLD "CLOUD"</td> <td>1</td> <td>PZ</td> </tr> </tbody> </table>	Code	Description	Qty	UOM	VM1761A0	D16 BLACK ELLIPTICAL SUPPORT	5	PZ	VM1762A0	INNER LAMP SUPPORT	4	PZ	VM1767A0	GREEN PILOT LIGHT W/ GOLD FLAME	1	PZ	VM1774A0	SILVER OPAQUE KEY W/ GOLD FLAME	1	PZ	VM1775A0	OPAQUE SILVER KEY WITH GOLD "CLOUD"	1	PZ	VM1902A0	NEUTRAL GREEN PLASTIC COVER FOR	1	PZ	VM1903A0	GREEN PILOT WITH GOLD "CLOUD"	1	PZ
					Code	Description	Qty	UOM																													
					VM1761A0	D16 BLACK ELLIPTICAL SUPPORT	5	PZ																													
					VM1762A0	INNER LAMP SUPPORT	4	PZ																													
					VM1767A0	GREEN PILOT LIGHT W/ GOLD FLAME	1	PZ																													
					VM1774A0	SILVER OPAQUE KEY W/ GOLD FLAME	1	PZ																													
					VM1775A0	OPAQUE SILVER KEY WITH GOLD "CLOUD"	1	PZ																													
					VM1902A0	NEUTRAL GREEN PLASTIC COVER FOR	1	PZ																													
					VM1903A0	GREEN PILOT WITH GOLD "CLOUD"	1	PZ																													
			KLP1014A	SINUSOID LED LIGHT+COVER+SUPPORT KIT	<table border="1"> <thead> <tr> <th>Code</th> <th>Description</th> <th>Qty</th> <th>UOM</th> </tr> </thead> <tbody> <tr> <td>VE1170A0</td> <td>D16 OPAQUE NICKEL ELLIPTICAL SUPPORT</td> <td>2</td> <td>PZ</td> </tr> <tr> <td>VE1535A1</td> <td>230V WHITE LED</td> <td>2</td> <td>PZ</td> </tr> <tr> <td>VE1585A0</td> <td>BLUE LIGHT COVER GOLD SINUSOID</td> <td>2</td> <td>PZ</td> </tr> <tr> <td>VM1762A0</td> <td>INNER LAMP SUPPORT</td> <td>2</td> <td>PZ</td> </tr> <tr> <td>VM2009A0</td> <td>ELLIPTICAL SILVER SUPPORT D16</td> <td>1</td> <td>PZ</td> </tr> </tbody> </table>	Code	Description	Qty	UOM	VE1170A0	D16 OPAQUE NICKEL ELLIPTICAL SUPPORT	2	PZ	VE1535A1	230V WHITE LED	2	PZ	VE1585A0	BLUE LIGHT COVER GOLD SINUSOID	2	PZ	VM1762A0	INNER LAMP SUPPORT	2	PZ	VM2009A0	ELLIPTICAL SILVER SUPPORT D16	1	PZ								
					Code	Description	Qty	UOM																													
					VE1170A0	D16 OPAQUE NICKEL ELLIPTICAL SUPPORT	2	PZ																													
					VE1535A1	230V WHITE LED	2	PZ																													
					VE1585A0	BLUE LIGHT COVER GOLD SINUSOID	2	PZ																													
					VM1762A0	INNER LAMP SUPPORT	2	PZ																													
VM2009A0	ELLIPTICAL SILVER SUPPORT D16	1	PZ																																		
KLP1012A	BLUE LIGHT THERMOMETER KIT	<table border="1"> <thead> <tr> <th>Code</th> <th>Description</th> <th>Qty</th> <th>UOM</th> </tr> </thead> <tbody> <tr> <td>VE1170A0</td> <td>D16 OPAQUE NICKEL ELLIPTICAL SUPPORT</td> <td>1</td> <td>PZ</td> </tr> <tr> <td>VE1530A0</td> <td>GOLD THERMOMETE R BLUE LIGHT COVER</td> <td>1</td> <td>PZ</td> </tr> <tr> <td>VE1535A1</td> <td>230V WHITE LED</td> <td>1</td> <td>PZ</td> </tr> <tr> <td>VM1762A0</td> <td>INNER LAMP SUPPORT</td> <td>1</td> <td>PZ</td> </tr> </tbody> </table>	Code	Description	Qty	UOM	VE1170A0	D16 OPAQUE NICKEL ELLIPTICAL SUPPORT	1	PZ	VE1530A0	GOLD THERMOMETE R BLUE LIGHT COVER	1	PZ	VE1535A1	230V WHITE LED	1	PZ	VM1762A0	INNER LAMP SUPPORT	1	PZ															
		Code	Description	Qty	UOM																																
		VE1170A0	D16 OPAQUE NICKEL ELLIPTICAL SUPPORT	1	PZ																																
		VE1530A0	GOLD THERMOMETE R BLUE LIGHT COVER	1	PZ																																
		VE1535A1	230V WHITE LED	1	PZ																																
VM1762A0	INNER LAMP SUPPORT	1	PZ																																		

COMPONENT			SPARE PART																						
Code	Description	Image	Code	Description	Components list																				
VE1535A	230V WHITE LED		KLP1010A	THERMOSTAT GREEN LIGHT KIT	<table border="1"> <thead> <tr> <th>Code</th> <th>Description</th> <th>Qty</th> <th>UOM</th> </tr> </thead> <tbody> <tr> <td>VE1170A0</td> <td>D16 OPAQUE NICKEL ELLIPTICAL SUPPORT</td> <td>1</td> <td>PZ</td> </tr> <tr> <td>VE1535A1</td> <td>230V WHITE LED</td> <td>1</td> <td>PZ</td> </tr> <tr> <td>VM1762A0</td> <td>INNER LAMP SUPPORT</td> <td>1</td> <td>PZ</td> </tr> <tr> <td>VM1764A0</td> <td>GREEN PILOT WITH GOLD THERMOMETE</td> <td>1</td> <td>PZ</td> </tr> </tbody> </table>	Code	Description	Qty	UOM	VE1170A0	D16 OPAQUE NICKEL ELLIPTICAL SUPPORT	1	PZ	VE1535A1	230V WHITE LED	1	PZ	VM1762A0	INNER LAMP SUPPORT	1	PZ	VM1764A0	GREEN PILOT WITH GOLD THERMOMETE	1	PZ
					Code	Description	Qty	UOM																	
					VE1170A0	D16 OPAQUE NICKEL ELLIPTICAL SUPPORT	1	PZ																	
					VE1535A1	230V WHITE LED	1	PZ																	
VM1762A0	INNER LAMP SUPPORT	1	PZ																						
VM1764A0	GREEN PILOT WITH GOLD THERMOMETE	1	PZ																						
TM1005A	MI2 60 MIN 250V 16A TIMER		KTM1005A	60 MIN TIMER KIT	<table border="1"> <thead> <tr> <th>Code</th> <th>Description</th> <th>Qty</th> <th>UOM</th> </tr> </thead> <tbody> <tr> <td>TM1005A0</td> <td>MI2 60 MIN 250V 16A TIME</td> <td>1</td> <td>PZ</td> </tr> <tr> <td>V11850A0</td> <td>M4X6 NICKEL PLATED FIXING SCRE</td> <td>2</td> <td>PZ</td> </tr> </tbody> </table>	Code	Description	Qty	UOM	TM1005A0	MI2 60 MIN 250V 16A TIME	1	PZ	V11850A0	M4X6 NICKEL PLATED FIXING SCRE	2	PZ								
					Code	Description	Qty	UOM																	
					TM1005A0	MI2 60 MIN 250V 16A TIME	1	PZ																	
V11850A0	M4X6 NICKEL PLATED FIXING SCRE	2	PZ																						
TR1100A	269°C 55.19052.80 ADJUSTABLE THERMOSTAT		KTR1100A	269°C THERMOSTAT KIT	<table border="1"> <thead> <tr> <th>Code</th> <th>Description</th> <th>Qty</th> <th>UOM</th> </tr> </thead> <tbody> <tr> <td>TR1100A0</td> <td>269°C 55.19052.80 ADJUSTABLE THERMOSTAT</td> <td>1</td> <td>PZ</td> </tr> <tr> <td>V11850A0</td> <td>M4X6 NICKEL PLATED FIXING SCRE</td> <td>2</td> <td>PZ</td> </tr> </tbody> </table>	Code	Description	Qty	UOM	TR1100A0	269°C 55.19052.80 ADJUSTABLE THERMOSTAT	1	PZ	V11850A0	M4X6 NICKEL PLATED FIXING SCRE	2	PZ								
					Code	Description	Qty	UOM																	
TR1100A0	269°C 55.19052.80 ADJUSTABLE THERMOSTAT	1	PZ																						
V11850A0	M4X6 NICKEL PLATED FIXING SCRE	2	PZ																						
TM1001C	15 SEC 120V ELECTRONIC BUZZE		KTM1001C	15 SEC BUZZER KIT	<table border="1"> <thead> <tr> <th>Code</th> <th>Description</th> <th>Qty</th> <th>UOM</th> </tr> </thead> <tbody> <tr> <td>TM1001C2</td> <td>15 SEC 120V ELECTRONIC BUZZER</td> <td>1</td> <td>PZ</td> </tr> <tr> <td>V11220A1</td> <td>4,2X12 TCB SELF-TAPPIN G SCREW</td> <td>3</td> <td>PZ</td> </tr> <tr> <td>V11850A0</td> <td>M4X6 NICKEL PLATED FIXING SCRE</td> <td>3</td> <td>PZ</td> </tr> <tr> <td>VM1745A0</td> <td>CARD SUPPORT</td> <td>3</td> <td>PZ</td> </tr> </tbody> </table>	Code	Description	Qty	UOM	TM1001C2	15 SEC 120V ELECTRONIC BUZZER	1	PZ	V11220A1	4,2X12 TCB SELF-TAPPIN G SCREW	3	PZ	V11850A0	M4X6 NICKEL PLATED FIXING SCRE	3	PZ	VM1745A0	CARD SUPPORT	3	PZ
					Code	Description	Qty	UOM																	
					TM1001C2	15 SEC 120V ELECTRONIC BUZZER	1	PZ																	
					V11220A1	4,2X12 TCB SELF-TAPPIN G SCREW	3	PZ																	
V11850A0	M4X6 NICKEL PLATED FIXING SCRE	3	PZ																						
VM1745A0	CARD SUPPORT	3	PZ																						

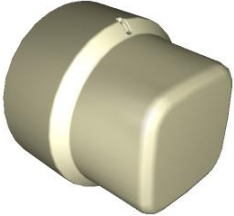
COMPONENT			SPARE PART																																																																		
Code	Description	Image	Code	Description	Components list																																																																
VM1390B	LINEMICRO LISA-ANNA CONTROL PANEL		KVM1390B	LINEMICRO LISA-ANNA CONTROL PANEL KI	<table border="1"> <thead> <tr> <th>Code</th> <th>Description</th> <th>Qty</th> <th>UOM</th> </tr> </thead> <tbody> <tr> <td>CE1155A0</td> <td>6,3X0,81 - 2,5 ALPACA FEMALE FASTON</td> <td>2</td> <td>PZ</td> </tr> <tr> <td>CE1235A0</td> <td>Ø0,75 MMQ UNIPOLAR WHITE WIRE</td> <td>0.900</td> <td>M</td> </tr> <tr> <td>CE1395A0</td> <td>6,3 X 0,8 MALE FASTO</td> <td>2</td> <td>PZ</td> </tr> <tr> <td>CE1660A0</td> <td>6,3X0,8 FEMALE FASTON COVE</td> <td>2</td> <td>PZ</td> </tr> <tr> <td>CE1661A0</td> <td>MALE FASTON COVER 6,3X0,</td> <td>2</td> <td>PZ</td> </tr> <tr> <td>ED1070A0</td> <td>78X33 UNOX LOGO STICKE</td> <td>1</td> <td>PZ</td> </tr> <tr> <td>VE1170A0</td> <td>D16 OPAQUE NICKEL ELLIPTICAL SUPPORT</td> <td>1</td> <td>PZ</td> </tr> <tr> <td>VE1530A0</td> <td>GOLD THERMOMETE R BLUE LIGHT COVER</td> <td>1</td> <td>PZ</td> </tr> <tr> <td>VE1535A1</td> <td>230V WHITE LED</td> <td>1</td> <td>PZ</td> </tr> <tr> <td>VI1220A1</td> <td>4,2X12 TCB SELF-TAPPIN G SCREW</td> <td>3</td> <td>PZ</td> </tr> <tr> <td>VM1390B0</td> <td>LINEMICRO LISA-ANNA CONTROL PANEL</td> <td>1</td> <td>PZ</td> </tr> <tr> <td>VM1390B1</td> <td>LMC 600 CONTROL BOARD</td> <td>1</td> <td>PZ</td> </tr> <tr> <td>VM1782A0</td> <td>INNER LAMP SUPPORT</td> <td>1</td> <td>PZ</td> </tr> <tr> <td>VM1794A0</td> <td>250X4.8 PA66 BLACK CLAMP</td> <td>2</td> <td>PZ</td> </tr> <tr> <td>VM2103A0</td> <td>CLAMP LOCK</td> <td>2</td> <td>PZ</td> </tr> </tbody> </table>	Code	Description	Qty	UOM	CE1155A0	6,3X0,81 - 2,5 ALPACA FEMALE FASTON	2	PZ	CE1235A0	Ø0,75 MMQ UNIPOLAR WHITE WIRE	0.900	M	CE1395A0	6,3 X 0,8 MALE FASTO	2	PZ	CE1660A0	6,3X0,8 FEMALE FASTON COVE	2	PZ	CE1661A0	MALE FASTON COVER 6,3X0,	2	PZ	ED1070A0	78X33 UNOX LOGO STICKE	1	PZ	VE1170A0	D16 OPAQUE NICKEL ELLIPTICAL SUPPORT	1	PZ	VE1530A0	GOLD THERMOMETE R BLUE LIGHT COVER	1	PZ	VE1535A1	230V WHITE LED	1	PZ	VI1220A1	4,2X12 TCB SELF-TAPPIN G SCREW	3	PZ	VM1390B0	LINEMICRO LISA-ANNA CONTROL PANEL	1	PZ	VM1390B1	LMC 600 CONTROL BOARD	1	PZ	VM1782A0	INNER LAMP SUPPORT	1	PZ	VM1794A0	250X4.8 PA66 BLACK CLAMP	2	PZ	VM2103A0	CLAMP LOCK	2	PZ
Code	Description	Qty	UOM																																																																		
CE1155A0	6,3X0,81 - 2,5 ALPACA FEMALE FASTON	2	PZ																																																																		
CE1235A0	Ø0,75 MMQ UNIPOLAR WHITE WIRE	0.900	M																																																																		
CE1395A0	6,3 X 0,8 MALE FASTO	2	PZ																																																																		
CE1660A0	6,3X0,8 FEMALE FASTON COVE	2	PZ																																																																		
CE1661A0	MALE FASTON COVER 6,3X0,	2	PZ																																																																		
ED1070A0	78X33 UNOX LOGO STICKE	1	PZ																																																																		
VE1170A0	D16 OPAQUE NICKEL ELLIPTICAL SUPPORT	1	PZ																																																																		
VE1530A0	GOLD THERMOMETE R BLUE LIGHT COVER	1	PZ																																																																		
VE1535A1	230V WHITE LED	1	PZ																																																																		
VI1220A1	4,2X12 TCB SELF-TAPPIN G SCREW	3	PZ																																																																		
VM1390B0	LINEMICRO LISA-ANNA CONTROL PANEL	1	PZ																																																																		
VM1390B1	LMC 600 CONTROL BOARD	1	PZ																																																																		
VM1782A0	INNER LAMP SUPPORT	1	PZ																																																																		
VM1794A0	250X4.8 PA66 BLACK CLAMP	2	PZ																																																																		
VM2103A0	CLAMP LOCK	2	PZ																																																																		
MN1100A	L.MICRO 0-60 MINUTES TIMER KNOB		KMN1100A	L.MICRO TIMER KNOB KIT	<table border="1"> <thead> <tr> <th>Code</th> <th>Description</th> <th>Qty</th> <th>UOM</th> </tr> </thead> <tbody> <tr> <td>MN1100A1</td> <td>L.MICRO 0-60 MINUTES TIMER KNOB</td> <td>1</td> <td>PZ</td> </tr> </tbody> </table>	Code	Description	Qty	UOM	MN1100A1	L.MICRO 0-60 MINUTES TIMER KNOB	1	PZ																																																								
Code	Description	Qty	UOM																																																																		
MN1100A1	L.MICRO 0-60 MINUTES TIMER KNOB	1	PZ																																																																		

COMPONENT			SPARE PART																		
Code	Description	Image	Code	Description	Components list																
MN1101B	80-260 °C THERMOSTAT KNOB		KMN1101B	LINE MICRO 80-260 °C THERMOSTAT KNOB KIT	<table border="1"> <thead> <tr> <th>Code</th> <th>Description</th> <th>Qty</th> <th>UOM</th> </tr> </thead> <tbody> <tr> <td>MN1101B1</td> <td>80-260 °C THERMOSTAT KNOB</td> <td>1</td> <td>PZ</td> </tr> </tbody> </table>	Code	Description	Qty	UOM	MN1101B1	80-260 °C THERMOSTAT KNOB	1	PZ								
Code	Description	Qty	UOM																		
MN1101B1	80-260 °C THERMOSTAT KNOB	1	PZ																		
CR1070A	HINGE LATCH L. C.		KCR1070A	LM HINGES LATCH 2 PCS. KIT	<table border="1"> <thead> <tr> <th>Code</th> <th>Description</th> <th>Qty</th> <th>UOM</th> </tr> </thead> <tbody> <tr> <td>CR1070A0</td> <td>HINGE LATCH L. C.</td> <td>2</td> <td>PZ</td> </tr> <tr> <td>VI1875A0</td> <td>SCREW M5X10 TC1/2T INOX</td> <td>4</td> <td>PZ</td> </tr> </tbody> </table>	Code	Description	Qty	UOM	CR1070A0	HINGE LATCH L. C.	2	PZ	VI1875A0	SCREW M5X10 TC1/2T INOX	4	PZ				
Code	Description	Qty	UOM																		
CR1070A0	HINGE LATCH L. C.	2	PZ																		
VI1875A0	SCREW M5X10 TC1/2T INOX	4	PZ																		
TR1134A	335 °C BIPOLAR SAFETY THERMOSTAT		KTR1134A	335 °C SAFETY THERMOSTAT KIT	<table border="1"> <thead> <tr> <th>Code</th> <th>Description</th> <th>Qty</th> <th>UOM</th> </tr> </thead> <tbody> <tr> <td>TR1134A0</td> <td>335 °C BIPOLAR SAFETY THERMOSTAT</td> <td>1</td> <td>PZ</td> </tr> </tbody> </table>	Code	Description	Qty	UOM	TR1134A0	335 °C BIPOLAR SAFETY THERMOSTAT	1	PZ								
Code	Description	Qty	UOM																		
TR1134A0	335 °C BIPOLAR SAFETY THERMOSTAT	1	PZ																		
VE1145A	CONDENSER 3.5 ?F 450 VAC 50/60 HZ		KCN1010A	3.5UF MOTOR CAPACITOR KIT	<table border="1"> <thead> <tr> <th>Code</th> <th>Description</th> <th>Qty</th> <th>UOM</th> </tr> </thead> <tbody> <tr> <td>CN1010A0</td> <td>MOTOR CAPACITOR 3.5?F 450V,CE/UL,P CLASS</td> <td>1</td> <td>PZ</td> </tr> <tr> <td>VI1931A0</td> <td>M8 NUT+INDENTE D WASHER D=8 X COND.</td> <td>1</td> <td>PZ</td> </tr> <tr> <td>VI1932A0</td> <td>M8 NUT+INDENTE D WASHER D=8 X COND.</td> <td>1</td> <td>PZ</td> </tr> </tbody> </table>	Code	Description	Qty	UOM	CN1010A0	MOTOR CAPACITOR 3.5?F 450V,CE/UL,P CLASS	1	PZ	VI1931A0	M8 NUT+INDENTE D WASHER D=8 X COND.	1	PZ	VI1932A0	M8 NUT+INDENTE D WASHER D=8 X COND.	1	PZ
Code	Description	Qty	UOM																		
CN1010A0	MOTOR CAPACITOR 3.5?F 450V,CE/UL,P CLASS	1	PZ																		
VI1931A0	M8 NUT+INDENTE D WASHER D=8 X COND.	1	PZ																		
VI1932A0	M8 NUT+INDENTE D WASHER D=8 X COND.	1	PZ																		
VM1950A	PLASTIC DRIP FLAP																				

**ASM0315A/0.D01 - Door**

**FRONT**

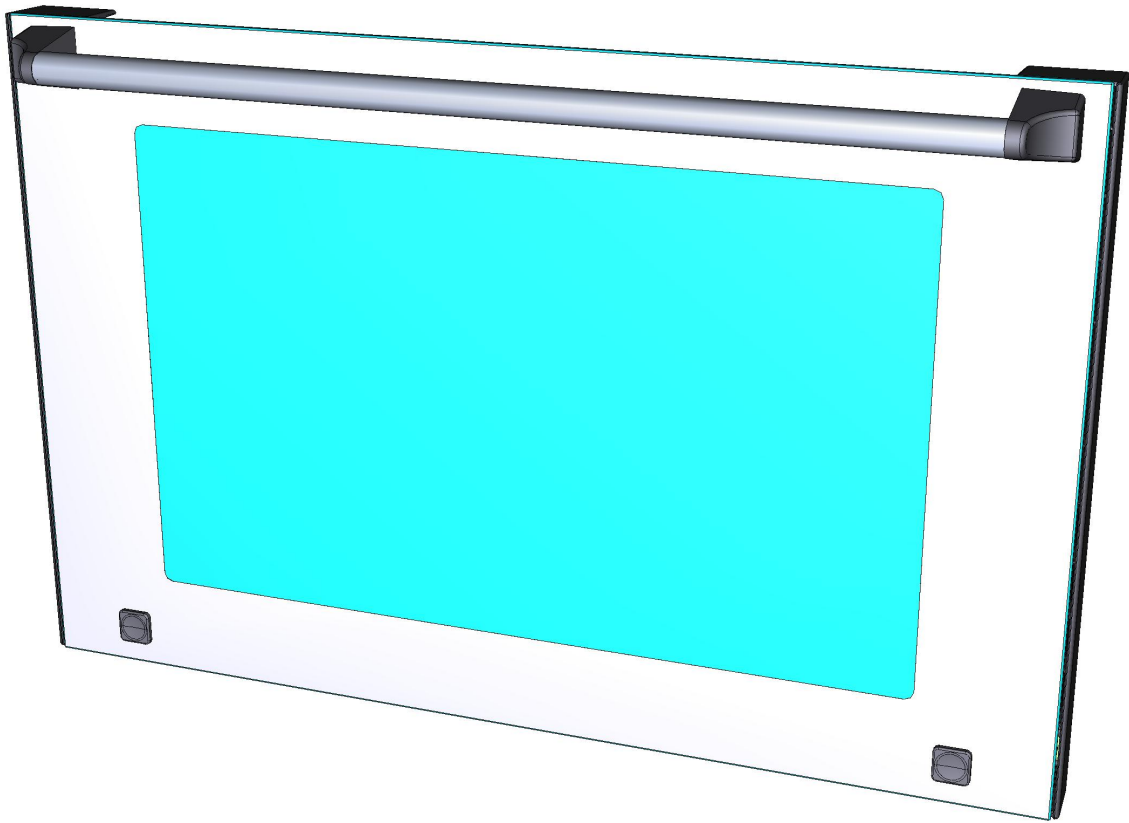



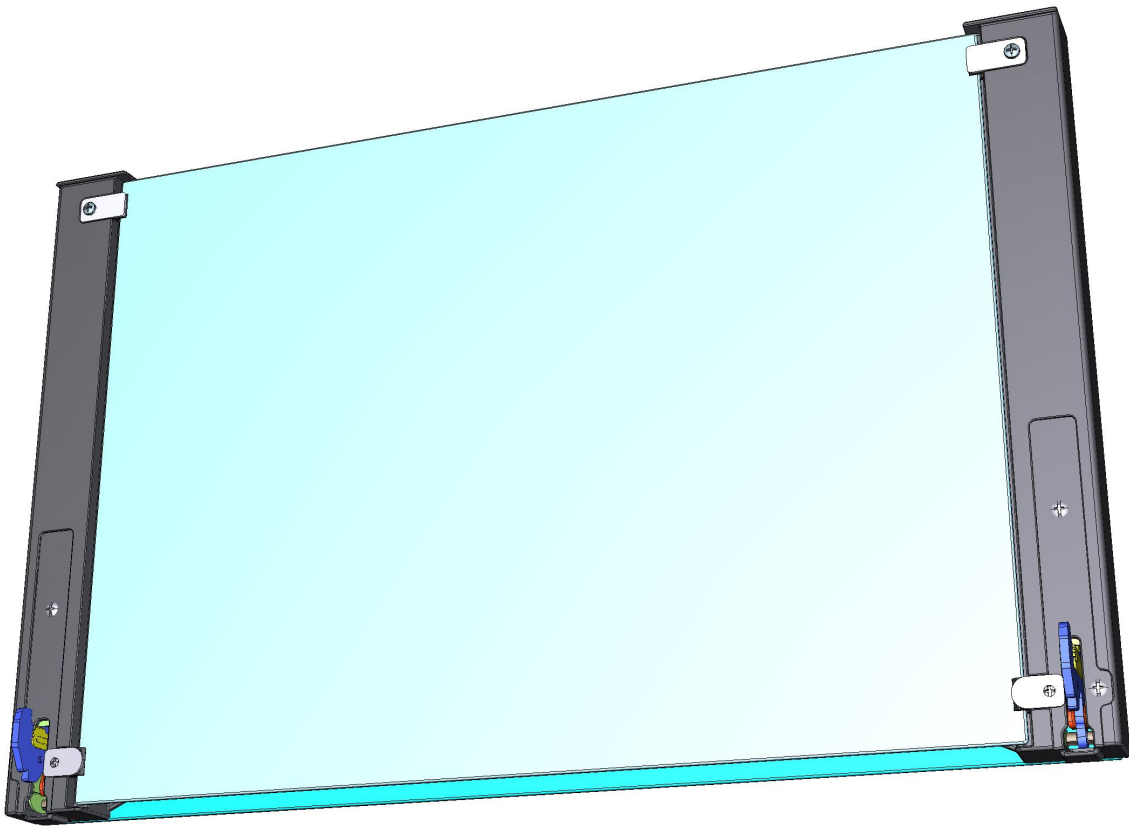

ASM0315A/0.D01 - Door

REAR







COMPONENT			SPARE PART																																										
Code	Description	Image	Code	Description	Components list																																								
VM1375A	LEFT DOOR COLUMN L. MICRO ANNA		KVM1375A	XF023-XF043 LEFT DOOR COLUMN KIT	<table border="1"> <thead> <tr> <th>Code</th> <th>Description</th> <th>Qty</th> <th>UOM</th> </tr> </thead> <tbody> <tr> <td>0H3110A1</td> <td>GLASS HOLDING ST.STEEL UPPER PLATE</td> <td>1</td> <td>PZ</td> </tr> <tr> <td>0H3111A2</td> <td>GLASS HOLDING ST.STEEL LOWER PLATE</td> <td>1</td> <td>PZ</td> </tr> <tr> <td>GN1240A0</td> <td>COLUMN-GLA SS BLACK SILICON SEAL</td> <td>2</td> <td>PZ</td> </tr> <tr> <td>VI1865A0</td> <td>5X10 TCB+ SELF-THREADI NG SCREW</td> <td>1</td> <td>PZ</td> </tr> <tr> <td>VI1870A0</td> <td>50X50 SELF-THREADI NG SCREW FOR PLASTIC</td> <td>1</td> <td>PZ</td> </tr> <tr> <td>VM1375A0</td> <td>LEFT DOOR COLUMN L. MICRO ANNA</td> <td>1</td> <td>PZ</td> </tr> <tr> <td>VM1380B0</td> <td>L.MICRO GLASS-DOOR FIXING CAP</td> <td>1</td> <td>PZ</td> </tr> <tr> <td>VM1794A0</td> <td>250X4.8 PA66 BLACK CLAMP</td> <td>2</td> <td>PZ</td> </tr> <tr> <td>VM2103A0</td> <td>CLAMP LOCK</td> <td>2</td> <td>PZ</td> </tr> </tbody> </table>	Code	Description	Qty	UOM	0H3110A1	GLASS HOLDING ST.STEEL UPPER PLATE	1	PZ	0H3111A2	GLASS HOLDING ST.STEEL LOWER PLATE	1	PZ	GN1240A0	COLUMN-GLA SS BLACK SILICON SEAL	2	PZ	VI1865A0	5X10 TCB+ SELF-THREADI NG SCREW	1	PZ	VI1870A0	50X50 SELF-THREADI NG SCREW FOR PLASTIC	1	PZ	VM1375A0	LEFT DOOR COLUMN L. MICRO ANNA	1	PZ	VM1380B0	L.MICRO GLASS-DOOR FIXING CAP	1	PZ	VM1794A0	250X4.8 PA66 BLACK CLAMP	2	PZ	VM2103A0	CLAMP LOCK	2	PZ
					Code	Description	Qty	UOM																																					
					0H3110A1	GLASS HOLDING ST.STEEL UPPER PLATE	1	PZ																																					
					0H3111A2	GLASS HOLDING ST.STEEL LOWER PLATE	1	PZ																																					
					GN1240A0	COLUMN-GLA SS BLACK SILICON SEAL	2	PZ																																					
					VI1865A0	5X10 TCB+ SELF-THREADI NG SCREW	1	PZ																																					
					VI1870A0	50X50 SELF-THREADI NG SCREW FOR PLASTIC	1	PZ																																					
					VM1375A0	LEFT DOOR COLUMN L. MICRO ANNA	1	PZ																																					
					VM1380B0	L.MICRO GLASS-DOOR FIXING CAP	1	PZ																																					
					VM1794A0	250X4.8 PA66 BLACK CLAMP	2	PZ																																					
VM2103A0	CLAMP LOCK	2	PZ																																										
VM1376A	L. MICRO ANNA RIGHT DOOR COLUMN		KVM1376A	XF023-XF043 RIGHT DOOR COLUMN KIT	<table border="1"> <thead> <tr> <th>Code</th> <th>Description</th> <th>Qty</th> <th>UOM</th> </tr> </thead> <tbody> <tr> <td>0H3110A1</td> <td>GLASS HOLDING ST.STEEL UPPER PLATE</td> <td>1</td> <td>PZ</td> </tr> <tr> <td>0H3111A2</td> <td>GLASS HOLDING ST.STEEL LOWER PLATE</td> <td>1</td> <td>PZ</td> </tr> <tr> <td>GN1240A0</td> <td>COLUMN-GLA SS BLACK SILICON SEAL</td> <td>2</td> <td>PZ</td> </tr> <tr> <td>VI1865A0</td> <td>5X10 TCB+ SELF-THREADI NG SCREW</td> <td>1</td> <td>PZ</td> </tr> <tr> <td>VI1870A0</td> <td>50X50 SELF-THREADI NG SCREW FOR PLASTIC</td> <td>1</td> <td>PZ</td> </tr> <tr> <td>VM1376A0</td> <td>L. MICRO ANNA RIGHT DOOR COLUM</td> <td>1</td> <td>PZ</td> </tr> <tr> <td>VM1380B0</td> <td>L.MICRO GLASS-DOOR FIXING CAP</td> <td>1</td> <td>PZ</td> </tr> <tr> <td>VM1794A0</td> <td>250X4.8 PA66 BLACK CLAMP</td> <td>2</td> <td>PZ</td> </tr> <tr> <td>VM2103A0</td> <td>CLAMP LOCK</td> <td>2</td> <td>PZ</td> </tr> </tbody> </table>	Code	Description	Qty	UOM	0H3110A1	GLASS HOLDING ST.STEEL UPPER PLATE	1	PZ	0H3111A2	GLASS HOLDING ST.STEEL LOWER PLATE	1	PZ	GN1240A0	COLUMN-GLA SS BLACK SILICON SEAL	2	PZ	VI1865A0	5X10 TCB+ SELF-THREADI NG SCREW	1	PZ	VI1870A0	50X50 SELF-THREADI NG SCREW FOR PLASTIC	1	PZ	VM1376A0	L. MICRO ANNA RIGHT DOOR COLUM	1	PZ	VM1380B0	L.MICRO GLASS-DOOR FIXING CAP	1	PZ	VM1794A0	250X4.8 PA66 BLACK CLAMP	2	PZ	VM2103A0	CLAMP LOCK	2	PZ
					Code	Description	Qty	UOM																																					
					0H3110A1	GLASS HOLDING ST.STEEL UPPER PLATE	1	PZ																																					
					0H3111A2	GLASS HOLDING ST.STEEL LOWER PLATE	1	PZ																																					
					GN1240A0	COLUMN-GLA SS BLACK SILICON SEAL	2	PZ																																					
					VI1865A0	5X10 TCB+ SELF-THREADI NG SCREW	1	PZ																																					
					VI1870A0	50X50 SELF-THREADI NG SCREW FOR PLASTIC	1	PZ																																					
					VM1376A0	L. MICRO ANNA RIGHT DOOR COLUM	1	PZ																																					
					VM1380B0	L.MICRO GLASS-DOOR FIXING CAP	1	PZ																																					
					VM1794A0	250X4.8 PA66 BLACK CLAMP	2	PZ																																					
VM2103A0	CLAMP LOCK	2	PZ																																										

COMPONENT			SPARE PART																																		
Code	Description	Image	Code	Description	Components list																																
VT1155A	INTERNAL GLASS 512X362X4 LINEMICRO XF023		KVT1155A	LINEMICRO XF023 INTERNAL GLASS KI	<table border="1"> <thead> <tr> <th>Code</th> <th>Description</th> <th>Qty</th> <th>UOM</th> </tr> </thead> <tbody> <tr> <td>ED1011A0</td> <td>GLASS LABEL</td> <td>1</td> <td>PZ</td> </tr> <tr> <td>ED1235A0</td> <td>INTERNAL GLASS LABEL</td> <td>1</td> <td>PZ</td> </tr> <tr> <td>GN1240A0</td> <td>COLUMN-GLA SS BLACK SILICON SEAL</td> <td>4</td> <td>PZ</td> </tr> <tr> <td>IP1508A1</td> <td>POLYSTYREN E U SHAPED PROFILE 2000X60X60</td> <td>0.880</td> <td>M</td> </tr> <tr> <td>VM1059A1</td> <td>HEAT SHRINK FILM H800</td> <td>1.300</td> <td>M</td> </tr> <tr> <td>VT1155A0</td> <td>INTERNAL GLASS 512X362X4 LINEMICRO XF023</td> <td>1</td> <td>PZ</td> </tr> <tr> <td>VT1155A0</td> <td>INTERNAL GLASS 512X362X4 LINEMICRO XF023</td> <td>1</td> <td>PZ</td> </tr> </tbody> </table>	Code	Description	Qty	UOM	ED1011A0	GLASS LABEL	1	PZ	ED1235A0	INTERNAL GLASS LABEL	1	PZ	GN1240A0	COLUMN-GLA SS BLACK SILICON SEAL	4	PZ	IP1508A1	POLYSTYREN E U SHAPED PROFILE 2000X60X60	0.880	M	VM1059A1	HEAT SHRINK FILM H800	1.300	M	VT1155A0	INTERNAL GLASS 512X362X4 LINEMICRO XF023	1	PZ	VT1155A0	INTERNAL GLASS 512X362X4 LINEMICRO XF023	1	PZ
Code	Description	Qty	UOM																																		
ED1011A0	GLASS LABEL	1	PZ																																		
ED1235A0	INTERNAL GLASS LABEL	1	PZ																																		
GN1240A0	COLUMN-GLA SS BLACK SILICON SEAL	4	PZ																																		
IP1508A1	POLYSTYREN E U SHAPED PROFILE 2000X60X60	0.880	M																																		
VM1059A1	HEAT SHRINK FILM H800	1.300	M																																		
VT1155A0	INTERNAL GLASS 512X362X4 LINEMICRO XF023	1	PZ																																		
VT1155A0	INTERNAL GLASS 512X362X4 LINEMICRO XF023	1	PZ																																		
MG1015B	L.MISS/L.MICRO/CH EFTOP HANDLE END		KMG1015B	2 PCS. HANDLE END KIT	<table border="1"> <thead> <tr> <th>Code</th> <th>Description</th> <th>Qty</th> <th>UOM</th> </tr> </thead> <tbody> <tr> <td>MG1015B0</td> <td>L.MISS/L.MICR O/CHEFTOP HANDLE END</td> <td>2</td> <td>PZ</td> </tr> <tr> <td>VI1855A0</td> <td>5X25 SELF-TAPPIN G SCREW</td> <td>2</td> <td>PZ</td> </tr> <tr> <td>VI1870A0</td> <td>50X50 SELF-THREADI NG SCREW FOR PLASTIC</td> <td>2</td> <td>PZ</td> </tr> <tr> <td>VM1025A0</td> <td>Ø16 GREY NYLON LID</td> <td>2</td> <td>PZ</td> </tr> </tbody> </table>	Code	Description	Qty	UOM	MG1015B0	L.MISS/L.MICR O/CHEFTOP HANDLE END	2	PZ	VI1855A0	5X25 SELF-TAPPIN G SCREW	2	PZ	VI1870A0	50X50 SELF-THREADI NG SCREW FOR PLASTIC	2	PZ	VM1025A0	Ø16 GREY NYLON LID	2	PZ												
Code	Description	Qty	UOM																																		
MG1015B0	L.MISS/L.MICR O/CHEFTOP HANDLE END	2	PZ																																		
VI1855A0	5X25 SELF-TAPPIN G SCREW	2	PZ																																		
VI1870A0	50X50 SELF-THREADI NG SCREW FOR PLASTIC	2	PZ																																		
VM1025A0	Ø16 GREY NYLON LID	2	PZ																																		
0H3195B	HANDLE TUBE L= 508 Ø18X1		K0H3195B	LMICRO HANDLE KI	<table border="1"> <thead> <tr> <th>Code</th> <th>Description</th> <th>Qty</th> <th>UOM</th> </tr> </thead> <tbody> <tr> <td>0H3195B0</td> <td>HANDLE TUBE L= 508 Ø18X1</td> <td>1</td> <td>PZ</td> </tr> <tr> <td>MG1015B0</td> <td>L.MISS/L.MICR O/CHEFTOP HANDLE END</td> <td>2</td> <td>PZ</td> </tr> <tr> <td>VI1870A0</td> <td>50X50 SELF-THREADI NG SCREW FOR PLASTIC</td> <td>2</td> <td>PZ</td> </tr> <tr> <td>VM1025A0</td> <td>Ø16 GREY NYLON LID</td> <td>2</td> <td>PZ</td> </tr> <tr> <td>VM1794A0</td> <td>250X4.8 PA66 BLACK CLAMP</td> <td>2</td> <td>PZ</td> </tr> <tr> <td>VM2103A0</td> <td>CLAMP LOCK</td> <td>2</td> <td>PZ</td> </tr> </tbody> </table>	Code	Description	Qty	UOM	0H3195B0	HANDLE TUBE L= 508 Ø18X1	1	PZ	MG1015B0	L.MISS/L.MICR O/CHEFTOP HANDLE END	2	PZ	VI1870A0	50X50 SELF-THREADI NG SCREW FOR PLASTIC	2	PZ	VM1025A0	Ø16 GREY NYLON LID	2	PZ	VM1794A0	250X4.8 PA66 BLACK CLAMP	2	PZ	VM2103A0	CLAMP LOCK	2	PZ				
Code	Description	Qty	UOM																																		
0H3195B0	HANDLE TUBE L= 508 Ø18X1	1	PZ																																		
MG1015B0	L.MISS/L.MICR O/CHEFTOP HANDLE END	2	PZ																																		
VI1870A0	50X50 SELF-THREADI NG SCREW FOR PLASTIC	2	PZ																																		
VM1025A0	Ø16 GREY NYLON LID	2	PZ																																		
VM1794A0	250X4.8 PA66 BLACK CLAMP	2	PZ																																		
VM2103A0	CLAMP LOCK	2	PZ																																		





COMPONENT			SPARE PART																																																																		
Code	Description	Image	Code	Description	Components list																																																																
CR1065A	LINEMICRO ANNA DOOR HINGE		KCR1065A	LINEMICRO XF023 DOOR HINGES KIT	<table border="1"> <thead> <tr> <th>Code</th> <th>Description</th> <th>Qty</th> <th>UOM</th> </tr> </thead> <tbody> <tr> <td>CR1065A0</td> <td>LINEMICRO ANNA DOOR HINGE</td> <td>2</td> <td>PZ</td> </tr> <tr> <td>VI1875A0</td> <td>SCREW M5X10 TC1/2T INOX</td> <td>6</td> <td>PZ</td> </tr> </tbody> </table>	Code	Description	Qty	UOM	CR1065A0	LINEMICRO ANNA DOOR HINGE	2	PZ	VI1875A0	SCREW M5X10 TC1/2T INOX	6	PZ																																																				
Code	Description	Qty	UOM																																																																		
CR1065A0	LINEMICRO ANNA DOOR HINGE	2	PZ																																																																		
VI1875A0	SCREW M5X10 TC1/2T INOX	6	PZ																																																																		
GN1240A	COLUMN-GLASS BLACK SILICON SEA		<p>KVT1190B</p> <p>KVT1190A</p> <p>KVT1155A</p>	<p>LINEMICRO XF043 INTERNAL GLASS KI</p> <p>DOMENICA INT. GLASS KIT VT1190A</p> <p>LINEMICRO XF023 INTERNAL GLASS KI</p>	<table border="1"> <thead> <tr> <th>Code</th> <th>Description</th> <th>Qty</th> <th>UOM</th> </tr> </thead> <tbody> <tr> <td>ED1011A0</td> <td>GLASS LABEL</td> <td>1</td> <td>PZ</td> </tr> <tr> <td>ED1235A0</td> <td>INTERNAL GLASS LABEL</td> <td>1</td> <td>PZ</td> </tr> <tr> <td>GN1240A0</td> <td>COLUMN-GLA SS BLACK SILICON SEAL</td> <td>4</td> <td>PZ</td> </tr> <tr> <td>IP1508A1</td> <td>POLYSTYREN E U SHAPED PROFILE 2000X60X60</td> <td>1.050</td> <td>M</td> </tr> <tr> <td>VM1059A1</td> <td>HEAT SHRINK FILM H800</td> <td>1.600</td> <td>M</td> </tr> <tr> <td>VT1190B0</td> <td>LINEMICRO XF043 712X372X4 INTERNAL GLASS</td> <td>1</td> <td>PZ</td> </tr> <tr> <td>VT1190B0</td> <td>LINEMICRO XF043 712X372X4 INTERNAL GLASS</td> <td>1</td> <td>PZ</td> </tr> <tr> <td>ED1235A0</td> <td>INTERNAL GLASS LABEL</td> <td>1</td> <td>PZ</td> </tr> <tr> <td>GN1240A0</td> <td>COLUMN-GLA SS BLACK SILICON SEAL</td> <td>4</td> <td>PZ</td> </tr> <tr> <td>IP1385A1</td> <td>CORNER POLYSTYREN E PACKING 110X80X2000</td> <td>1</td> <td>M</td> </tr> <tr> <td>VT1190A0</td> <td></td> <td>1</td> <td>PZ</td> </tr> <tr> <td>VT1190A0</td> <td></td> <td>1</td> <td>PZ</td> </tr> <tr> <td>ED1011A0</td> <td>GLASS LABEL</td> <td>1</td> <td>PZ</td> </tr> <tr> <td>ED1235A0</td> <td>INTERNAL GLASS LABEL</td> <td>1</td> <td>PZ</td> </tr> <tr> <td>GN1240A0</td> <td>COLUMN-GLA SS BLACK SILICON SEAL</td> <td>4</td> <td>PZ</td> </tr> </tbody> </table>	Code	Description	Qty	UOM	ED1011A0	GLASS LABEL	1	PZ	ED1235A0	INTERNAL GLASS LABEL	1	PZ	GN1240A0	COLUMN-GLA SS BLACK SILICON SEAL	4	PZ	IP1508A1	POLYSTYREN E U SHAPED PROFILE 2000X60X60	1.050	M	VM1059A1	HEAT SHRINK FILM H800	1.600	M	VT1190B0	LINEMICRO XF043 712X372X4 INTERNAL GLASS	1	PZ	VT1190B0	LINEMICRO XF043 712X372X4 INTERNAL GLASS	1	PZ	ED1235A0	INTERNAL GLASS LABEL	1	PZ	GN1240A0	COLUMN-GLA SS BLACK SILICON SEAL	4	PZ	IP1385A1	CORNER POLYSTYREN E PACKING 110X80X2000	1	M	VT1190A0		1	PZ	VT1190A0		1	PZ	ED1011A0	GLASS LABEL	1	PZ	ED1235A0	INTERNAL GLASS LABEL	1	PZ	GN1240A0	COLUMN-GLA SS BLACK SILICON SEAL	4	PZ
Code	Description	Qty	UOM																																																																		
ED1011A0	GLASS LABEL	1	PZ																																																																		
ED1235A0	INTERNAL GLASS LABEL	1	PZ																																																																		
GN1240A0	COLUMN-GLA SS BLACK SILICON SEAL	4	PZ																																																																		
IP1508A1	POLYSTYREN E U SHAPED PROFILE 2000X60X60	1.050	M																																																																		
VM1059A1	HEAT SHRINK FILM H800	1.600	M																																																																		
VT1190B0	LINEMICRO XF043 712X372X4 INTERNAL GLASS	1	PZ																																																																		
VT1190B0	LINEMICRO XF043 712X372X4 INTERNAL GLASS	1	PZ																																																																		
ED1235A0	INTERNAL GLASS LABEL	1	PZ																																																																		
GN1240A0	COLUMN-GLA SS BLACK SILICON SEAL	4	PZ																																																																		
IP1385A1	CORNER POLYSTYREN E PACKING 110X80X2000	1	M																																																																		
VT1190A0		1	PZ																																																																		
VT1190A0		1	PZ																																																																		
ED1011A0	GLASS LABEL	1	PZ																																																																		
ED1235A0	INTERNAL GLASS LABEL	1	PZ																																																																		
GN1240A0	COLUMN-GLA SS BLACK SILICON SEAL	4	PZ																																																																		







COMPONENT			SPARE PART																															
Code	Description	Image	Code	Description	Components list																													
GN1240A	COLUMN-GLASS BLACK SILICON SEA		KVT1155A	LINEMICRO XF023 INTERNAL GLASS KI	<table border="1"> <thead> <tr> <th>Code</th> <th>Description</th> <th>Qty</th> <th>UOM</th> </tr> </thead> <tbody> <tr> <td>IP1508A1</td> <td>POLYSTYREN E U SHAPED PROFILE 2000X60X60</td> <td>0.880</td> <td>M</td> </tr> <tr> <td>VM1059A1</td> <td>HEAT SHRINK FILM H800</td> <td>1.300</td> <td>M</td> </tr> <tr> <td>VT1155A0</td> <td>INTERNAL GLASS 512X362X4 LINEMICRO XF023</td> <td>1</td> <td>PZ</td> </tr> <tr> <td>VT1155A0</td> <td>INTERNAL GLASS 512X362X4 LINEMICRO XF023</td> <td>1</td> <td>PZ</td> </tr> </tbody> </table>	Code	Description	Qty	UOM	IP1508A1	POLYSTYREN E U SHAPED PROFILE 2000X60X60	0.880	M	VM1059A1	HEAT SHRINK FILM H800	1.300	M	VT1155A0	INTERNAL GLASS 512X362X4 LINEMICRO XF023	1	PZ	VT1155A0	INTERNAL GLASS 512X362X4 LINEMICRO XF023	1	PZ									
			Code	Description	Qty	UOM																												
			IP1508A1	POLYSTYREN E U SHAPED PROFILE 2000X60X60	0.880	M																												
VM1059A1	HEAT SHRINK FILM H800	1.300	M																															
VT1155A0	INTERNAL GLASS 512X362X4 LINEMICRO XF023	1	PZ																															
VT1155A0	INTERNAL GLASS 512X362X4 LINEMICRO XF023	1	PZ																															
KVT1150A	LINEMICRO XF013 INTERNAL GLASS KI	<table border="1"> <thead> <tr> <th>Code</th> <th>Description</th> <th>Qty</th> <th>UOM</th> </tr> </thead> <tbody> <tr> <td>ED1011A0</td> <td>GLASS LABEL</td> <td>1</td> <td>PZ</td> </tr> <tr> <td>ED1235A0</td> <td>INTERNAL GLASS LABEL</td> <td>1</td> <td>PZ</td> </tr> <tr> <td>GN1240A0</td> <td>COLUMN-GLA SS BLACK SILICON SEAL</td> <td>4</td> <td>PZ</td> </tr> <tr> <td>IP1508A1</td> <td>POLYSTYREN E U SHAPED PROFILE 2000X60X60</td> <td>0.820</td> <td>M</td> </tr> <tr> <td>VM1059A1</td> <td>HEAT SHRINK FILM H800</td> <td>1.300</td> <td>M</td> </tr> <tr> <td>VT1150A0</td> <td>INTERNAL GLASS 512X292X4 LINEMICRO XF003</td> <td>1</td> <td>PZ</td> </tr> <tr> <td>VT1150A0</td> <td>INTERNAL GLASS 512X292X4 LINEMICRO XF003</td> <td>1</td> <td>PZ</td> </tr> </tbody> </table>	Code	Description	Qty	UOM	ED1011A0	GLASS LABEL	1	PZ	ED1235A0	INTERNAL GLASS LABEL	1	PZ	GN1240A0	COLUMN-GLA SS BLACK SILICON SEAL	4	PZ	IP1508A1	POLYSTYREN E U SHAPED PROFILE 2000X60X60	0.820	M	VM1059A1	HEAT SHRINK FILM H800	1.300	M	VT1150A0	INTERNAL GLASS 512X292X4 LINEMICRO XF003	1	PZ	VT1150A0	INTERNAL GLASS 512X292X4 LINEMICRO XF003	1	PZ
Code	Description	Qty	UOM																															
ED1011A0	GLASS LABEL	1	PZ																															
ED1235A0	INTERNAL GLASS LABEL	1	PZ																															
GN1240A0	COLUMN-GLA SS BLACK SILICON SEAL	4	PZ																															
IP1508A1	POLYSTYREN E U SHAPED PROFILE 2000X60X60	0.820	M																															
VM1059A1	HEAT SHRINK FILM H800	1.300	M																															
VT1150A0	INTERNAL GLASS 512X292X4 LINEMICRO XF003	1	PZ																															
VT1150A0	INTERNAL GLASS 512X292X4 LINEMICRO XF003	1	PZ																															
KVT1145A	LINEMICRO XF003 INTERNAL GLASS KI	<table border="1"> <thead> <tr> <th>Code</th> <th>Description</th> <th>Qty</th> <th>UOM</th> </tr> </thead> <tbody> <tr> <td>ED1011A0</td> <td>GLASS LABEL</td> <td>1</td> <td>PZ</td> </tr> <tr> <td>ED1235A0</td> <td>INTERNAL GLASS LABEL</td> <td>1</td> <td>PZ</td> </tr> <tr> <td>GN1240A0</td> <td>COLUMN-GLA SS BLACK SILICON SEAL</td> <td>4</td> <td>PZ</td> </tr> <tr> <td>IP1508A1</td> <td>POLYSTYREN E U SHAPED PROFILE 2000X60X60</td> <td>0.710</td> <td>M</td> </tr> <tr> <td>VM1059A1</td> <td>HEAT SHRINK FILM H800</td> <td>1</td> <td>M</td> </tr> </tbody> </table>	Code	Description	Qty	UOM	ED1011A0	GLASS LABEL	1	PZ	ED1235A0	INTERNAL GLASS LABEL	1	PZ	GN1240A0	COLUMN-GLA SS BLACK SILICON SEAL	4	PZ	IP1508A1	POLYSTYREN E U SHAPED PROFILE 2000X60X60	0.710	M	VM1059A1	HEAT SHRINK FILM H800	1	M								
Code	Description	Qty	UOM																															
ED1011A0	GLASS LABEL	1	PZ																															
ED1235A0	INTERNAL GLASS LABEL	1	PZ																															
GN1240A0	COLUMN-GLA SS BLACK SILICON SEAL	4	PZ																															
IP1508A1	POLYSTYREN E U SHAPED PROFILE 2000X60X60	0.710	M																															
VM1059A1	HEAT SHRINK FILM H800	1	M																															



COMPONENT			SPARE PART																																							
Code	Description	Image	Code	Description	Components list																																					
GN1240A	COLUMN-GLASS BLACK SILICON SEA		KVT1145A	LINEMICRO XF003 INTERNAL GLASS KI	<table border="1"> <thead> <tr> <th>Code</th> <th>Description</th> <th>Qty</th> <th>UOM</th> </tr> </thead> <tbody> <tr> <td>VT1145A0</td> <td>INNER GLASS 392X292X4 BETFL L</td> <td>1</td> <td>PZ</td> </tr> <tr> <td>VT1145A0</td> <td>INNER GLASS 392X292X4 BETFL L</td> <td>1</td> <td>PZ</td> </tr> </tbody> </table>	Code	Description	Qty	UOM	VT1145A0	INNER GLASS 392X292X4 BETFL L	1	PZ	VT1145A0	INNER GLASS 392X292X4 BETFL L	1	PZ																									
			Code	Description	Qty	UOM																																				
VT1145A0	INNER GLASS 392X292X4 BETFL L	1	PZ																																							
VT1145A0	INNER GLASS 392X292X4 BETFL L	1	PZ																																							
KVM1376A	XF023-XF043 RIGHT DOOR COLUMN KIT	<table border="1"> <thead> <tr> <th>Code</th> <th>Description</th> <th>Qty</th> <th>UOM</th> </tr> </thead> <tbody> <tr> <td>0H3110A1</td> <td>GLASS HOLDING ST.STEEL UPPER PLATE</td> <td>1</td> <td>PZ</td> </tr> <tr> <td>0H3111A2</td> <td>GLASS HOLDING ST.STEEL LOWER PLATE</td> <td>1</td> <td>PZ</td> </tr> <tr> <td>GN1240A0</td> <td>COLUMN-GLA SS BLACK SILICON SEAL</td> <td>2</td> <td>PZ</td> </tr> <tr> <td>VI1865A0</td> <td>5X10 TCB+ SELF-THREADI NG SCREW</td> <td>1</td> <td>PZ</td> </tr> <tr> <td>VI1870A0</td> <td>50X50 SELF-THREADI NG SCREW FOR PLASTIC</td> <td>1</td> <td>PZ</td> </tr> <tr> <td>VM1376A0</td> <td>L. MICRO ANNA RIGHT DOOR COLUM</td> <td>1</td> <td>PZ</td> </tr> <tr> <td>VM1380B0</td> <td>L.MICRO GLASS-DOOR FIXING CAP</td> <td>1</td> <td>PZ</td> </tr> <tr> <td>VM1794A0</td> <td>250X4.8 PA66 BLACK CLAMP</td> <td>2</td> <td>PZ</td> </tr> <tr> <td>VM2103A0</td> <td>CLAMP LOCK</td> <td>2</td> <td>PZ</td> </tr> </tbody> </table>	Code	Description	Qty	UOM	0H3110A1	GLASS HOLDING ST.STEEL UPPER PLATE	1	PZ	0H3111A2	GLASS HOLDING ST.STEEL LOWER PLATE	1	PZ	GN1240A0	COLUMN-GLA SS BLACK SILICON SEAL	2	PZ	VI1865A0	5X10 TCB+ SELF-THREADI NG SCREW	1	PZ	VI1870A0	50X50 SELF-THREADI NG SCREW FOR PLASTIC	1	PZ	VM1376A0	L. MICRO ANNA RIGHT DOOR COLUM	1	PZ	VM1380B0	L.MICRO GLASS-DOOR FIXING CAP	1	PZ	VM1794A0	250X4.8 PA66 BLACK CLAMP	2	PZ	VM2103A0	CLAMP LOCK	2	PZ
Code	Description	Qty	UOM																																							
0H3110A1	GLASS HOLDING ST.STEEL UPPER PLATE	1	PZ																																							
0H3111A2	GLASS HOLDING ST.STEEL LOWER PLATE	1	PZ																																							
GN1240A0	COLUMN-GLA SS BLACK SILICON SEAL	2	PZ																																							
VI1865A0	5X10 TCB+ SELF-THREADI NG SCREW	1	PZ																																							
VI1870A0	50X50 SELF-THREADI NG SCREW FOR PLASTIC	1	PZ																																							
VM1376A0	L. MICRO ANNA RIGHT DOOR COLUM	1	PZ																																							
VM1380B0	L.MICRO GLASS-DOOR FIXING CAP	1	PZ																																							
VM1794A0	250X4.8 PA66 BLACK CLAMP	2	PZ																																							
VM2103A0	CLAMP LOCK	2	PZ																																							
KVM1375A	XF023-XF043 LEFT DOOR COLUMN KIT	<table border="1"> <thead> <tr> <th>Code</th> <th>Description</th> <th>Qty</th> <th>UOM</th> </tr> </thead> <tbody> <tr> <td>0H3110A1</td> <td>GLASS HOLDING ST.STEEL UPPER PLATE</td> <td>1</td> <td>PZ</td> </tr> <tr> <td>0H3111A2</td> <td>GLASS HOLDING ST.STEEL LOWER PLATE</td> <td>1</td> <td>PZ</td> </tr> <tr> <td>GN1240A0</td> <td>COLUMN-GLA SS BLACK SILICON SEAL</td> <td>2</td> <td>PZ</td> </tr> <tr> <td>VI1865A0</td> <td>5X10 TCB+ SELF-THREADI NG SCREW</td> <td>1</td> <td>PZ</td> </tr> <tr> <td>VI1870A0</td> <td>50X50 SELF-THREADI NG SCREW FOR PLASTIC</td> <td>1</td> <td>PZ</td> </tr> </tbody> </table>	Code	Description	Qty	UOM	0H3110A1	GLASS HOLDING ST.STEEL UPPER PLATE	1	PZ	0H3111A2	GLASS HOLDING ST.STEEL LOWER PLATE	1	PZ	GN1240A0	COLUMN-GLA SS BLACK SILICON SEAL	2	PZ	VI1865A0	5X10 TCB+ SELF-THREADI NG SCREW	1	PZ	VI1870A0	50X50 SELF-THREADI NG SCREW FOR PLASTIC	1	PZ																
Code	Description	Qty	UOM																																							
0H3110A1	GLASS HOLDING ST.STEEL UPPER PLATE	1	PZ																																							
0H3111A2	GLASS HOLDING ST.STEEL LOWER PLATE	1	PZ																																							
GN1240A0	COLUMN-GLA SS BLACK SILICON SEAL	2	PZ																																							
VI1865A0	5X10 TCB+ SELF-THREADI NG SCREW	1	PZ																																							
VI1870A0	50X50 SELF-THREADI NG SCREW FOR PLASTIC	1	PZ																																							

COMPONENT			SPARE PART																															
Code	Description	Image	Code	Description	Components list																													
GN1240A	COLUMN-GLASS BLACK SILICON SEA		KVM1375A	XF023-XF043 LEFT DOOR COLUMN KIT	<table border="1"> <thead> <tr> <th>Code</th> <th>Description</th> <th>Qty</th> <th>UOM</th> </tr> </thead> <tbody> <tr> <td>VM1375A0</td> <td>LEFT DOOR COLUMN L. MICRO ANNA</td> <td>1</td> <td>PZ</td> </tr> <tr> <td>VM1380B0</td> <td>L.MICRO GLASS-DOOR FIXING CAP</td> <td>1</td> <td>PZ</td> </tr> <tr> <td>VM1794A0</td> <td>250X4.8 PA66 BLACK CLAMP</td> <td>2</td> <td>PZ</td> </tr> <tr> <td>VM2103A0</td> <td>CLAMP LOCK</td> <td>2</td> <td>PZ</td> </tr> </tbody> </table>	Code	Description	Qty	UOM	VM1375A0	LEFT DOOR COLUMN L. MICRO ANNA	1	PZ	VM1380B0	L.MICRO GLASS-DOOR FIXING CAP	1	PZ	VM1794A0	250X4.8 PA66 BLACK CLAMP	2	PZ	VM2103A0	CLAMP LOCK	2	PZ									
			Code	Description	Qty	UOM																												
			VM1375A0	LEFT DOOR COLUMN L. MICRO ANNA	1	PZ																												
VM1380B0	L.MICRO GLASS-DOOR FIXING CAP	1	PZ																															
VM1794A0	250X4.8 PA66 BLACK CLAMP	2	PZ																															
VM2103A0	CLAMP LOCK	2	PZ																															
KVM1371A	XF003-XF013 RIGHT DOOR COLUMN KIT	<table border="1"> <thead> <tr> <th>Code</th> <th>Description</th> <th>Qty</th> <th>UOM</th> </tr> </thead> <tbody> <tr> <td>0H3110A1</td> <td>GLASS HOLDING ST.STEEL UPPER PLATE</td> <td>1</td> <td>PZ</td> </tr> <tr> <td>0H3111A2</td> <td>GLASS HOLDING ST.STEEL LOWER PLATE</td> <td>1</td> <td>PZ</td> </tr> <tr> <td>GN1240A0</td> <td>COLUMN-GLA SS BLACK SILICON SEAL</td> <td>2</td> <td>PZ</td> </tr> <tr> <td>VI1865A0</td> <td>5X10 TCB+ SELF-THREADI NG SCREW</td> <td>1</td> <td>PZ</td> </tr> <tr> <td>VI1870A0</td> <td>50X50 SELF-THREADI NG SCREW FOR PLASTIC</td> <td>1</td> <td>PZ</td> </tr> <tr> <td>VM1371A0</td> <td>RIGHT DOOR COLUMN L. MICRO ROBERTA-LIS</td> <td>1</td> <td>PZ</td> </tr> <tr> <td>VM1380B0</td> <td>L.MICRO GLASS-DOOR FIXING CAP</td> <td>1</td> <td>PZ</td> </tr> </tbody> </table>	Code	Description	Qty	UOM	0H3110A1	GLASS HOLDING ST.STEEL UPPER PLATE	1	PZ	0H3111A2	GLASS HOLDING ST.STEEL LOWER PLATE	1	PZ	GN1240A0	COLUMN-GLA SS BLACK SILICON SEAL	2	PZ	VI1865A0	5X10 TCB+ SELF-THREADI NG SCREW	1	PZ	VI1870A0	50X50 SELF-THREADI NG SCREW FOR PLASTIC	1	PZ	VM1371A0	RIGHT DOOR COLUMN L. MICRO ROBERTA-LIS	1	PZ	VM1380B0	L.MICRO GLASS-DOOR FIXING CAP	1	PZ
Code	Description	Qty	UOM																															
0H3110A1	GLASS HOLDING ST.STEEL UPPER PLATE	1	PZ																															
0H3111A2	GLASS HOLDING ST.STEEL LOWER PLATE	1	PZ																															
GN1240A0	COLUMN-GLA SS BLACK SILICON SEAL	2	PZ																															
VI1865A0	5X10 TCB+ SELF-THREADI NG SCREW	1	PZ																															
VI1870A0	50X50 SELF-THREADI NG SCREW FOR PLASTIC	1	PZ																															
VM1371A0	RIGHT DOOR COLUMN L. MICRO ROBERTA-LIS	1	PZ																															
VM1380B0	L.MICRO GLASS-DOOR FIXING CAP	1	PZ																															
KVM1370A	XF003-XF013 LEFT DOOR COLUMN KIT	<table border="1"> <thead> <tr> <th>Code</th> <th>Description</th> <th>Qty</th> <th>UOM</th> </tr> </thead> <tbody> <tr> <td>0H3110A1</td> <td>GLASS HOLDING ST.STEEL UPPER PLATE</td> <td>1</td> <td>PZ</td> </tr> <tr> <td>0H3111A2</td> <td>GLASS HOLDING ST.STEEL LOWER PLATE</td> <td>1</td> <td>PZ</td> </tr> <tr> <td>GN1240A0</td> <td>COLUMN-GLA SS BLACK SILICON SEAL</td> <td>2</td> <td>PZ</td> </tr> <tr> <td>VI1865A0</td> <td>5X10 TCB+ SELF-THREADI NG SCREW</td> <td>1</td> <td>PZ</td> </tr> </tbody> </table>	Code	Description	Qty	UOM	0H3110A1	GLASS HOLDING ST.STEEL UPPER PLATE	1	PZ	0H3111A2	GLASS HOLDING ST.STEEL LOWER PLATE	1	PZ	GN1240A0	COLUMN-GLA SS BLACK SILICON SEAL	2	PZ	VI1865A0	5X10 TCB+ SELF-THREADI NG SCREW	1	PZ												
Code	Description	Qty	UOM																															
0H3110A1	GLASS HOLDING ST.STEEL UPPER PLATE	1	PZ																															
0H3111A2	GLASS HOLDING ST.STEEL LOWER PLATE	1	PZ																															
GN1240A0	COLUMN-GLA SS BLACK SILICON SEAL	2	PZ																															
VI1865A0	5X10 TCB+ SELF-THREADI NG SCREW	1	PZ																															

COMPONENT			SPARE PART																		
Code	Description	Image	Code	Description	Components list																
GN1240A	COLUMN-GLASS BLACK SILICON SEA		KVM1370A	XF003-XF013 LEFT DOOR COLUMN KIT	<table border="1"> <thead> <tr> <th>Code</th> <th>Description</th> <th>Qty</th> <th>UOM</th> </tr> </thead> <tbody> <tr> <td>VI1870A0</td> <td>50X50 SELF-THREADI NG SCREW FOR PLASTIC</td> <td>1</td> <td>PZ</td> </tr> <tr> <td>VM1370A0</td> <td>LEFT DOOR COLUMN L MICRO ROBERTA-LIS</td> <td>1</td> <td>PZ</td> </tr> <tr> <td>VM1380B0</td> <td>L.MICRO GLASS-DOOR FIXING CAP</td> <td>1</td> <td>PZ</td> </tr> </tbody> </table>	Code	Description	Qty	UOM	VI1870A0	50X50 SELF-THREADI NG SCREW FOR PLASTIC	1	PZ	VM1370A0	LEFT DOOR COLUMN L MICRO ROBERTA-LIS	1	PZ	VM1380B0	L.MICRO GLASS-DOOR FIXING CAP	1	PZ
			Code	Description	Qty	UOM															
VI1870A0	50X50 SELF-THREADI NG SCREW FOR PLASTIC	1	PZ																		
VM1370A0	LEFT DOOR COLUMN L MICRO ROBERTA-LIS	1	PZ																		
VM1380B0	L.MICRO GLASS-DOOR FIXING CAP	1	PZ																		
KG1240A	COLUMN-GLASS GASKET 4 PCS KIT	<table border="1"> <thead> <tr> <th>Code</th> <th>Description</th> <th>Qty</th> <th>UOM</th> </tr> </thead> <tbody> <tr> <td>GN1240A0</td> <td>COLUMN-GLA SS BLACK SILICON SEAL</td> <td>4</td> <td>PZ</td> </tr> </tbody> </table>	Code	Description	Qty	UOM	GN1240A0	COLUMN-GLA SS BLACK SILICON SEAL	4	PZ											
Code	Description	Qty	UOM																		
GN1240A0	COLUMN-GLA SS BLACK SILICON SEAL	4	PZ																		
0H3110A	GLASS HOLDING ST.STEEL UPPER PLATE		0H3110A1	GLASS HOLDING ST.STEEL UPPER PLATE																	
0H3111A	GLASS HOLDING ST.STEEL LOWER PLATE		0H3111A2	GLASS HOLDING ST.STEEL LOWER PLATE																	
VM1380B	L.MICRO GLASS-DOOR FIXING CAP		KVM1380B	LMICRO DOOR CAP 2 PCS KIT	<table border="1"> <thead> <tr> <th>Code</th> <th>Description</th> <th>Qty</th> <th>UOM</th> </tr> </thead> <tbody> <tr> <td>VI1865A0</td> <td>5X10 TCB+ SELF-THREADI NG SCREW</td> <td>2</td> <td>PZ</td> </tr> <tr> <td>VM1380B0</td> <td>L.MICRO GLASS-DOOR FIXING CAP</td> <td>2</td> <td>PZ</td> </tr> </tbody> </table>	Code	Description	Qty	UOM	VI1865A0	5X10 TCB+ SELF-THREADI NG SCREW	2	PZ	VM1380B0	L.MICRO GLASS-DOOR FIXING CAP	2	PZ				
			Code	Description	Qty	UOM															
VI1865A0	5X10 TCB+ SELF-THREADI NG SCREW	2	PZ																		
VM1380B0	L.MICRO GLASS-DOOR FIXING CAP	2	PZ																		

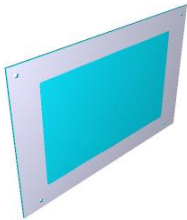

COMPONENT			SPARE PART																						
Code	Description	Image	Code	Description	Components list																				
VT1156A	LINEMICRO XF023 590X382X4 EXTERNAL GLASS		KVT1156A	LINEMICRO XF023 EXTERNAL GLASS KIT	<table border="1"> <thead> <tr> <th>Code</th> <th>Description</th> <th>Qty</th> <th>UOM</th> </tr> </thead> <tbody> <tr> <td>IP1508A1</td> <td>POLYSTYREN E U SHAPED PROFILE 2000X60X60</td> <td>2</td> <td>M</td> </tr> <tr> <td>VM1059A1</td> <td>HEAT SHRINK FILM H800</td> <td>1.400</td> <td>M</td> </tr> <tr> <td>VT1156A1</td> <td>LINEMICRO XF023 590X382X4 EXTERNAL GLASS</td> <td>1</td> <td>PZ</td> </tr> <tr> <td>VT1156A1</td> <td>LINEMICRO XF023 590X382X4 EXTERNAL GLASS</td> <td>1</td> <td>PZ</td> </tr> </tbody> </table>	Code	Description	Qty	UOM	IP1508A1	POLYSTYREN E U SHAPED PROFILE 2000X60X60	2	M	VM1059A1	HEAT SHRINK FILM H800	1.400	M	VT1156A1	LINEMICRO XF023 590X382X4 EXTERNAL GLASS	1	PZ	VT1156A1	LINEMICRO XF023 590X382X4 EXTERNAL GLASS	1	PZ
Code	Description	Qty	UOM																						
IP1508A1	POLYSTYREN E U SHAPED PROFILE 2000X60X60	2	M																						
VM1059A1	HEAT SHRINK FILM H800	1.400	M																						
VT1156A1	LINEMICRO XF023 590X382X4 EXTERNAL GLASS	1	PZ																						
VT1156A1	LINEMICRO XF023 590X382X4 EXTERNAL GLASS	1	PZ																						